

Quantum Oscillations, Magnetotransport and the Fermi Surface of cuprates

Cyril PROUST

*Laboratoire National des Champs Magnétiques Intenses
Toulouse*

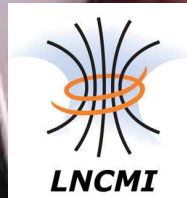

Collaborations



D. Vignolles

B. Vignolle

C. Jaudet

J. Levallois

A. Audouard

M. Nardone



K. Behnia



L. Taillefer

N. Doiron-Leyraud

D. LeBoeuf

J-B Bonnemaïson



D. Bonn

B. Ramshaw

J. Day

R. Liang

W. Hardy



N. Hussey

A. Carrington

A. Bangura

J. Fletcher

R. A. Cooper

M. M. J. French



University of
St Andrews

A.P. Mackenzie

Outline

- **Introduction to quantum oscillations**
- Quantum oscillations on both sides of the phase diagram
- The case for an electron pocket
- Cartography of the electron pocket
- Fermi surface reconstruction scenarios

Quantum theory

$$E = E_z + E_\perp = \frac{\hbar^2 k_z^2}{2m} + \hbar\omega_c \left(n + \frac{1}{2} \right) \quad \omega_c = \frac{qB}{m_c}$$

$$n(E) = 2\pi V \left(\frac{2m}{\hbar^2} \right)^{3/2} \hbar\omega_c \sum_{n=0}^{\infty} \frac{1}{\sqrt{E - \hbar\omega_c(n + 0.5)}}$$

Density of states

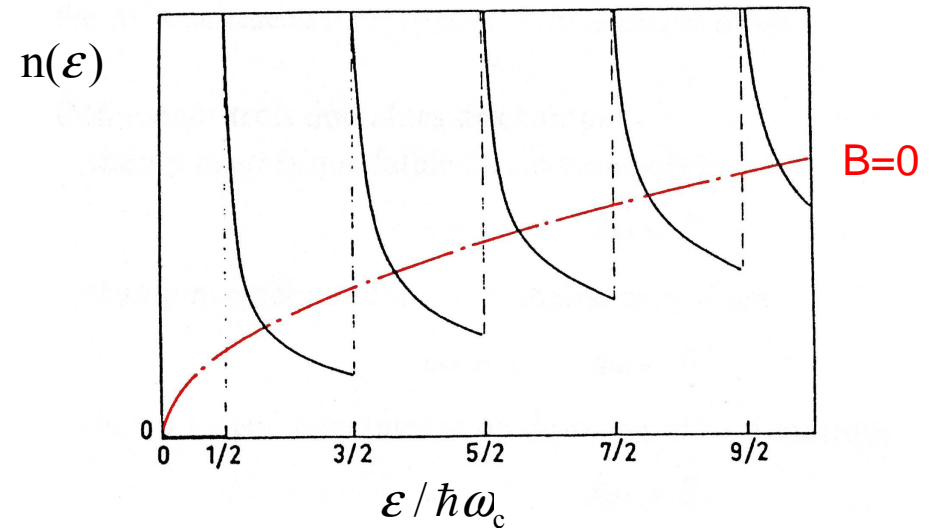
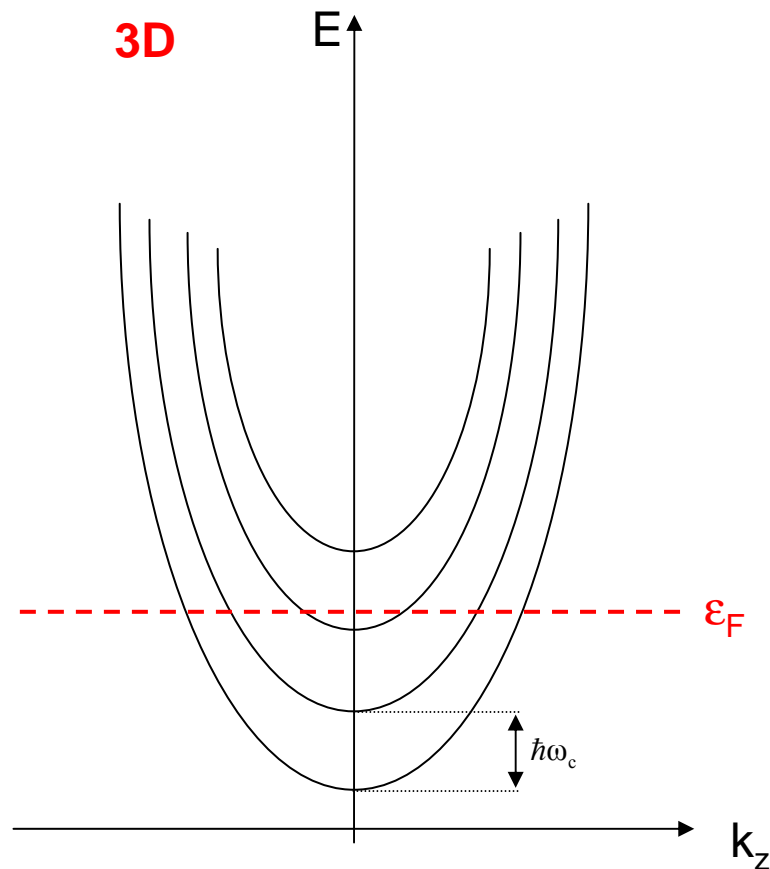

Oscillation of most electronic properties

Magnetization: de Haas-van Alphen (dHvA)

Resistivity: Shubnikov-de Haas (SdH)

Quantum theory

Temperature / Disorder effects on quantum oscillations

$$\omega_c = \frac{eB}{m^*}$$

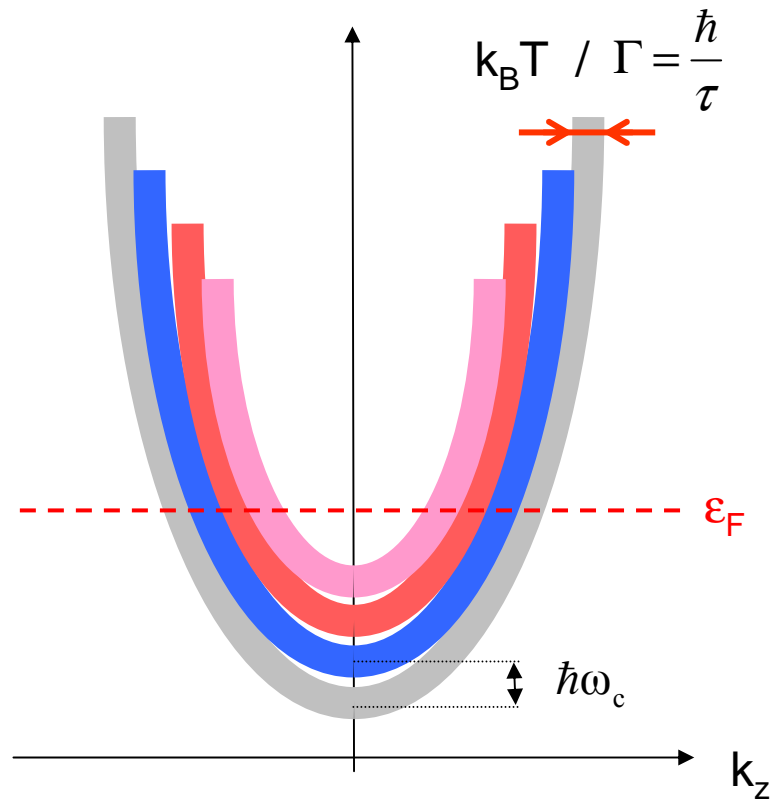

- **Low T measurements**

$$\hbar\omega_c > k_B T$$

- **Need high quality single crystals**

$$\hbar\omega_c > \frac{\hbar}{\tau} \Rightarrow \omega_c \tau > 1$$

Quantum theory

Lifshitz-Kosevich theory (1956)

$$\Delta R, \Delta M \propto R_T R_D R_S \sin \left[2\pi \left(\frac{F}{B} - \gamma \right) \right]$$

$$\frac{F}{B} = \frac{\hbar}{2\pi q} \frac{A_F}{B}$$

Onsager relation \Rightarrow

$$A_F$$

Extremal area

$$R_T = \frac{X}{sh(X)} \quad \text{where } X = 14.694 \times T m_c / B$$

\Rightarrow

$$m^*$$

Cyclotron mass

$$R_D = \exp\left(-\frac{14.694 \times T_D m_c}{B}\right) = \exp\left(-\frac{\pi}{\mu B}\right)$$

\Rightarrow

$$T_D = \frac{\hbar}{2\pi k_B \tau}$$

Dingle temperature
(mean free path)

$$R_S = \cos\left(\frac{\pi}{2} m_b^* g\right)$$

\Rightarrow

$$m_b^* g$$

Spin factor
(spin zero)

Direct measure of the Fermi surface extremal area

(but number of orbits ? location in k-space ?)

Outline

- Introduction to quantum oscillations
- **Quantum oscillations on both sides of the phase diagram**
- The case for an electron pocket
- Cartography of the electron pocket
- Fermi surface reconstruction scenarios

The overdoped case: $Tl_2Ba_2CuO_{6+\delta}$

Fermi surface of overdoped TI-2201

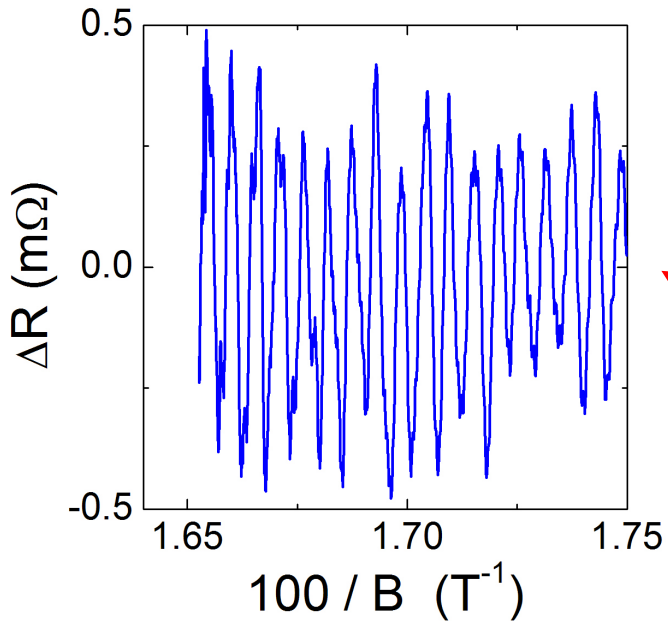

$$F = \frac{\Phi_0}{2\pi^2} A_k$$

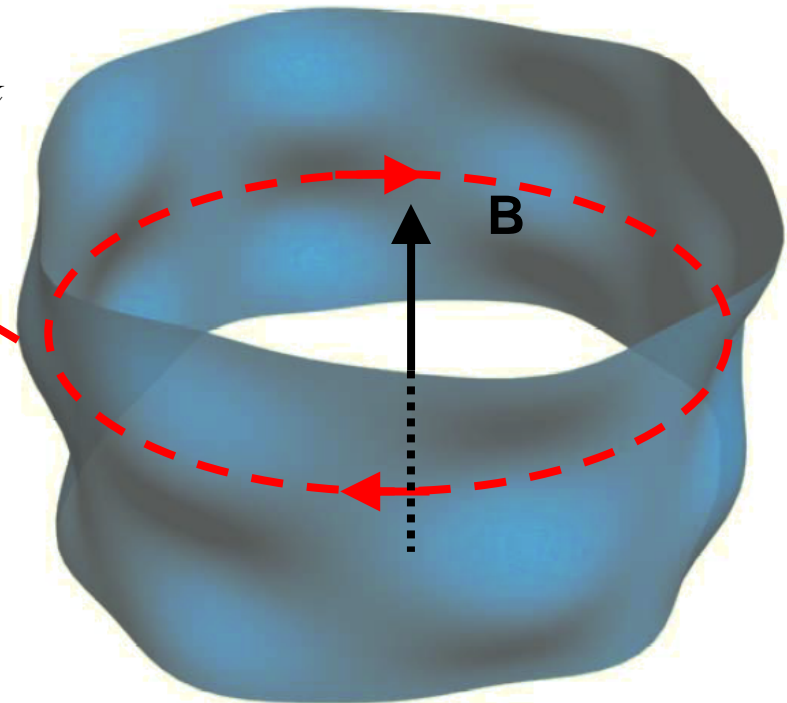
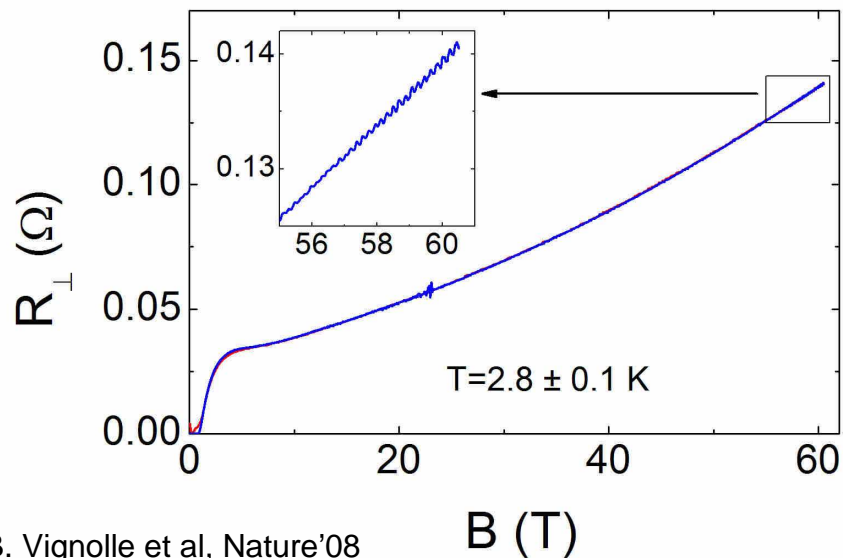

Photo credit: N. Hussey



Oscillation amplitude < 1% (1 mΩ)!

The overdoped case: $Tl_2Ba_2CuO_{6+\delta}$

- $F=18100 \pm 50$ T

Onsager relation :

$$F = \frac{\phi_0}{2\pi^2} A_k$$

$$A_k = \pi k_F^2 \Rightarrow k_F = 7.42 \pm 0.05 \text{ nm}^{-1}$$

(65 % of the FBZ)

Luttinger theorem :

$$n = \frac{2A_k}{(2\pi)^2} = \frac{F}{\phi_0}$$

\Rightarrow Carrier density: $n=1.3$ carrier /Cu atom ($n=1+p$ with $p=0.3$)

Electronic specific heat:

$$m^* = 5 \pm 0.5 m_0 \Rightarrow \gamma_{el} = \frac{\pi N_A k_B^2 a^2}{3\hbar^2} m^* = 7 \pm 0.5 \text{ mJ/mol.K}^2$$

For overdoped polycrystalline Tl-2201: $\gamma_{el} = 7 \pm 1 \text{ mJ/mol.K}^2$ (Loram et al, Physica C'94)

AMRO

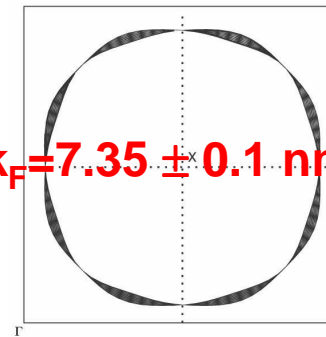

$$k_F = 7.35 \pm 0.1 \text{ nm}^{-1}$$

Hussey et al, Nature'03

ARPES

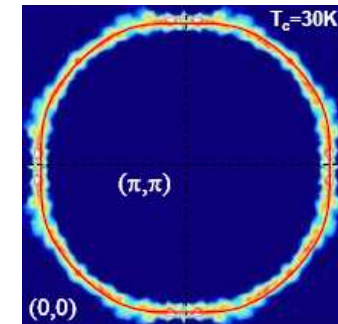

Platé et al, PRB'05

All the numbers are in excellent agreement with

- in-field probes: AMRO, Hall effect
- zero field probes: ARPES, thermodynamic ...

Quantum oscillations in UD $\text{YBa}_2\text{Cu}_3\text{O}_{6.5}$

Shubnikov - de Haas

$$F = \frac{\phi_0}{2\pi^2} A_k$$

de Haas – van Alphen

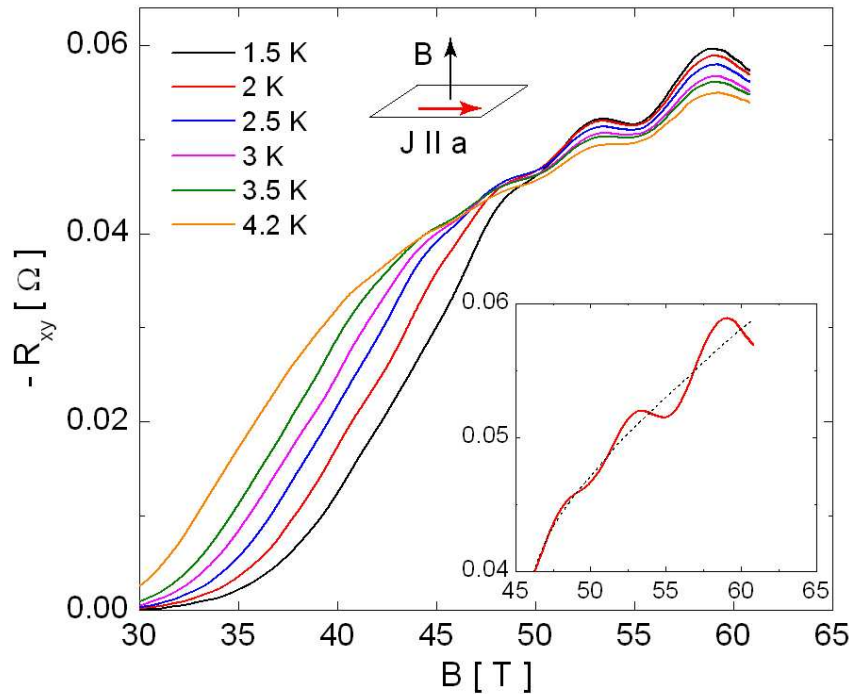

N. Doiron-Leyraud et al, Nature'07

Frequency : $F = (540 \pm 4) \text{ T}$
 Mass : $m^* = (1.76 \pm 0.07) m_0$

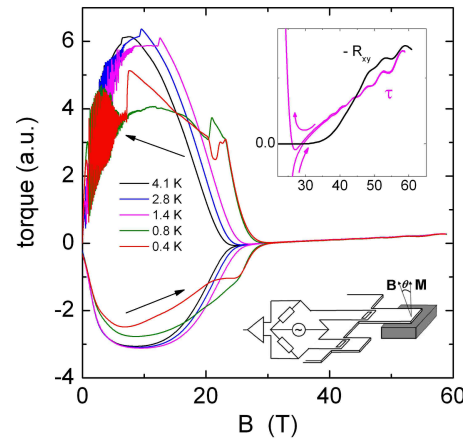

D. Vignolles



Piezoresistif cantilever

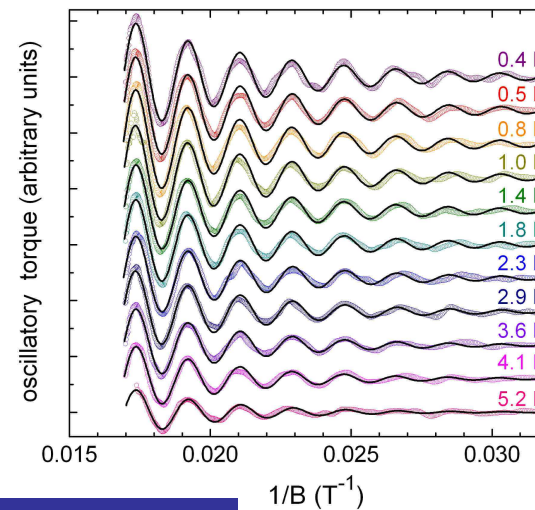

$1/B \text{ (T}^{-1}\text{)}$

C. Jaudet et al, PRL'08

Closed pocket and coherent QP at low T

Quantum oscillations in UD $\text{YBa}_2\text{Cu}_4\text{O}_8$

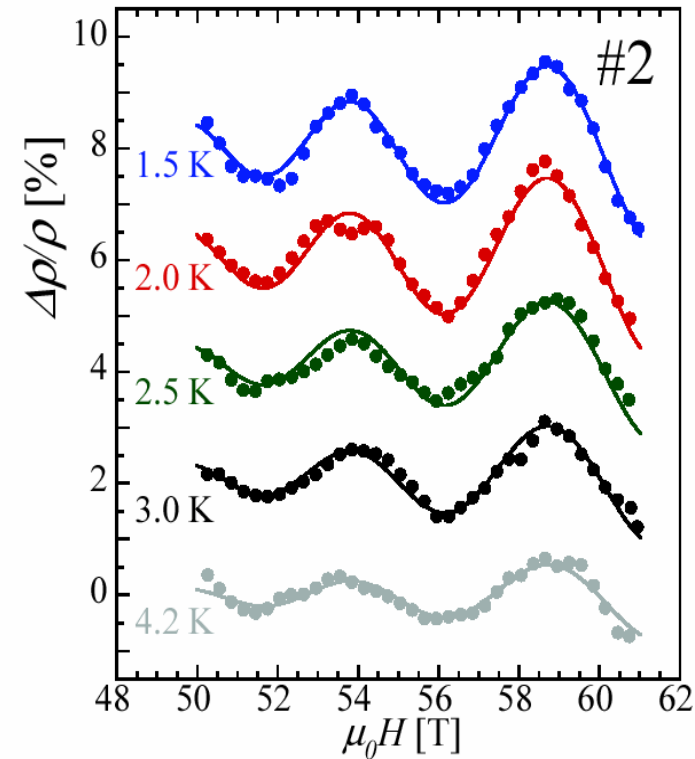
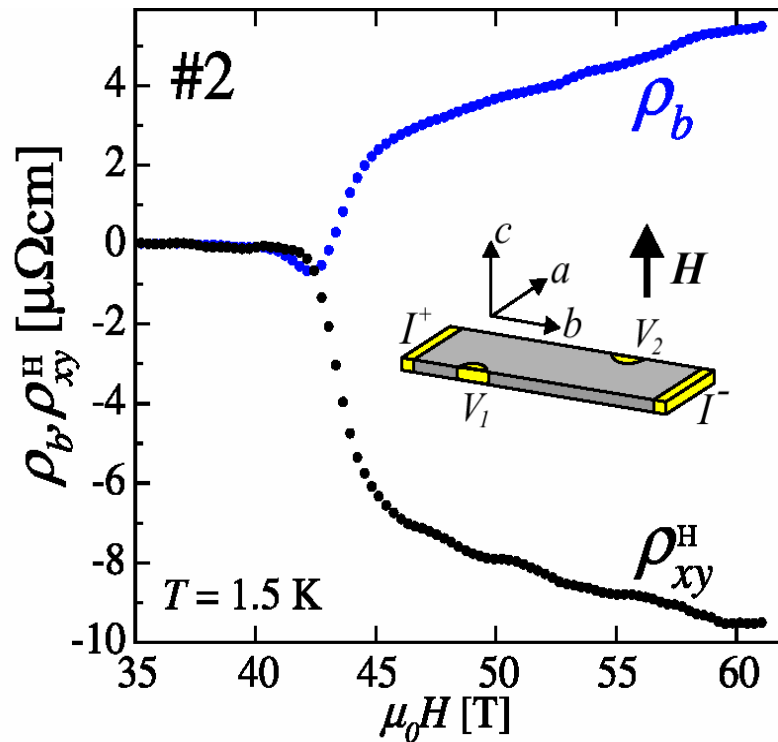

A. Bangura et al, PRL'08

Frequency : $F = (660 \pm 30) \text{ T}$
 Mass : $m^* = (2.7 \pm 0.3) m_0$

See also E.A Yelland et al, PRL'08

Quantum oscillations in HTSC

underdoped
 $\text{YBa}_2\text{Cu}_3\text{O}_{6.5}$

overdoped
 $\text{Tl}_2\text{Ba}_2\text{CuO}_{6+\delta}$

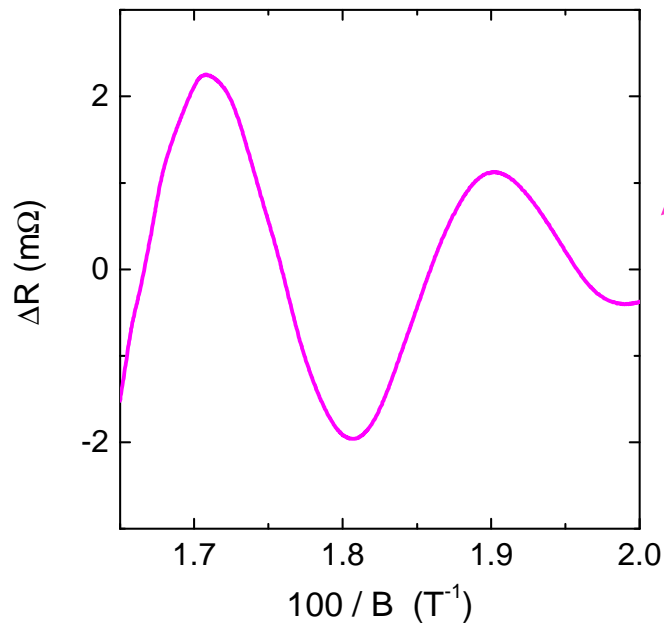
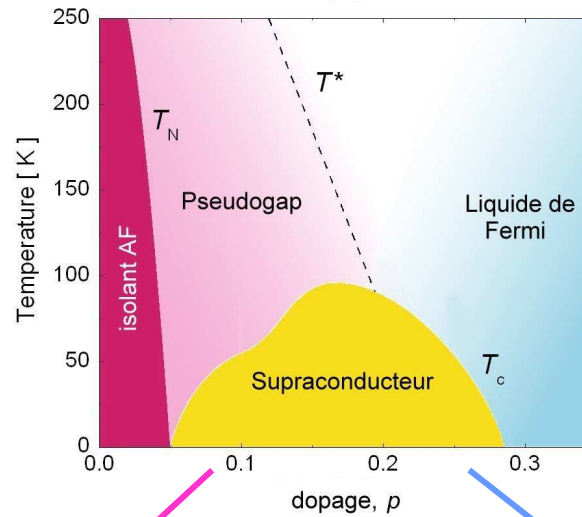

N. Doiron-Leyraud et al, Nature'07

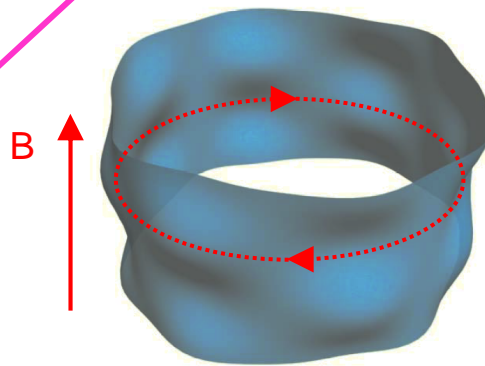

$$F = \frac{\phi_0}{2\pi^2} A_k$$

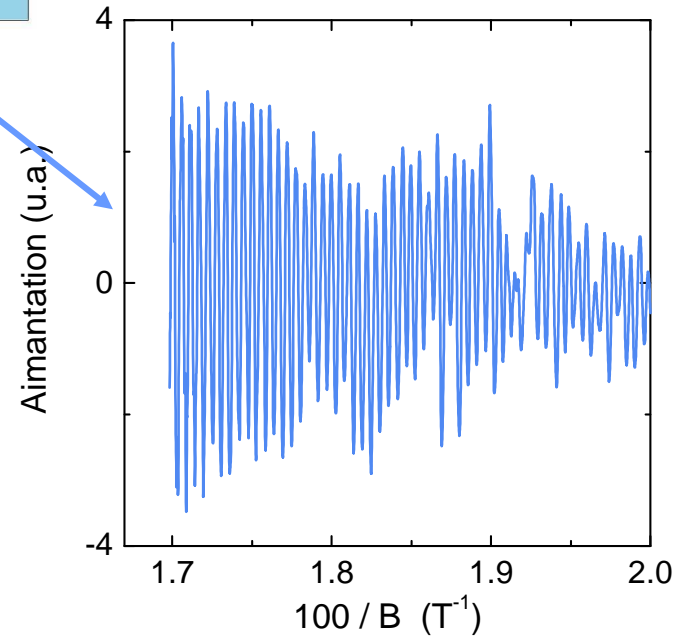

B. Vignolle et al, Nature'08

Implication of quantum oscillations

YBa₂Cu₃O_{6.5}

Frequency : $F = (530 \pm 20) T$

$A_k = 1.9\%$ of 1st Brillouin zone

Tl₂Ba₂CuO_{6+δ}

Frequency : $F = (18100 \pm 50) T$

$A_k = 65\%$ of 1st Brillouin zone

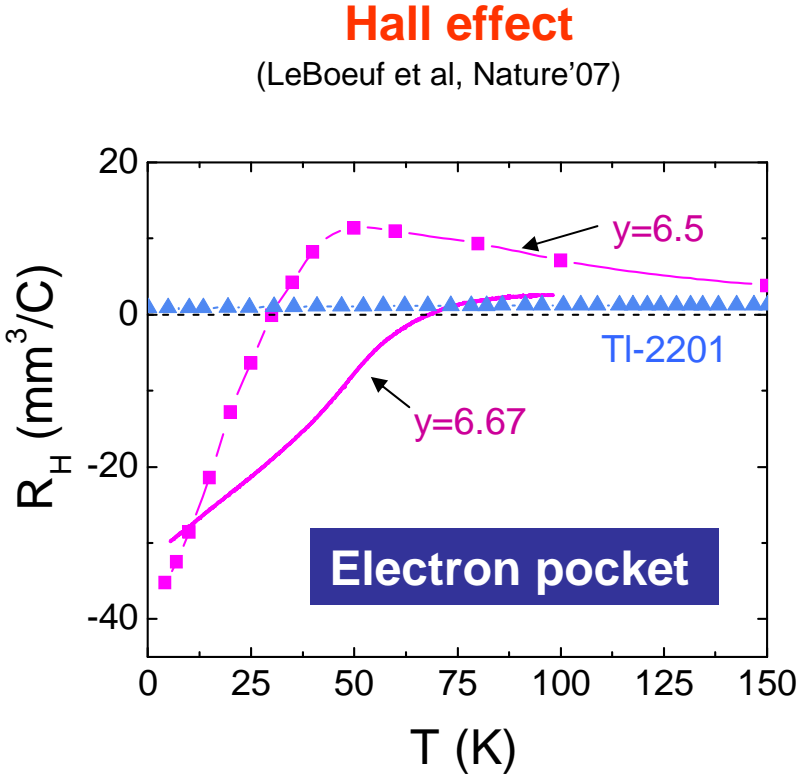
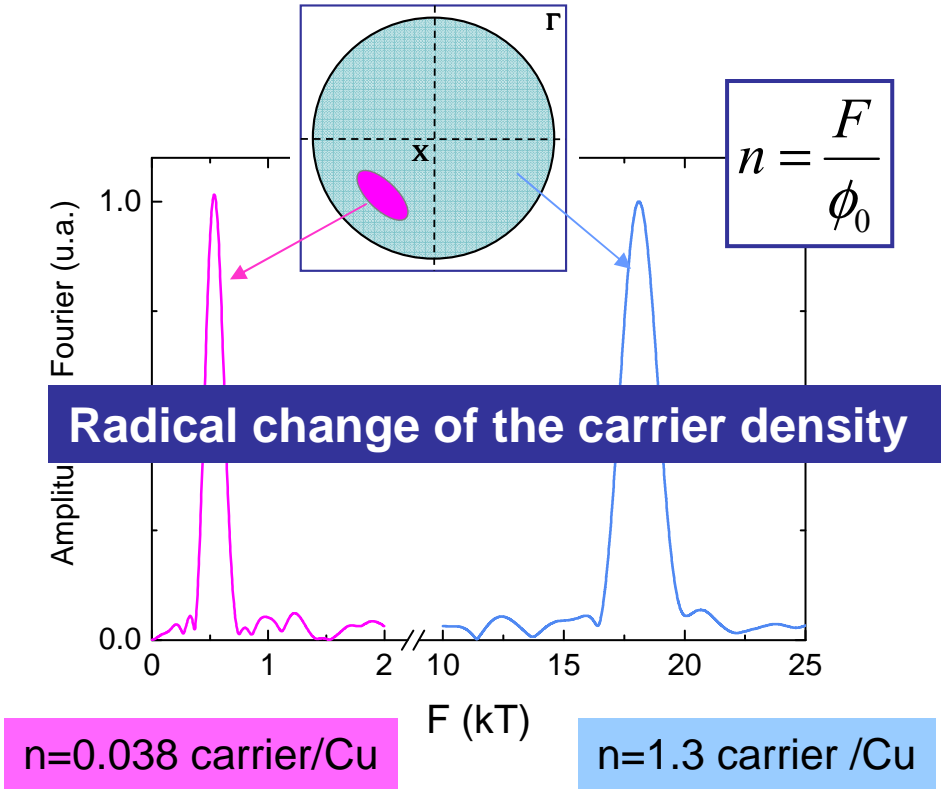

C. Jaudet et al, Physica B'09

Scenarios for the Fermi surface

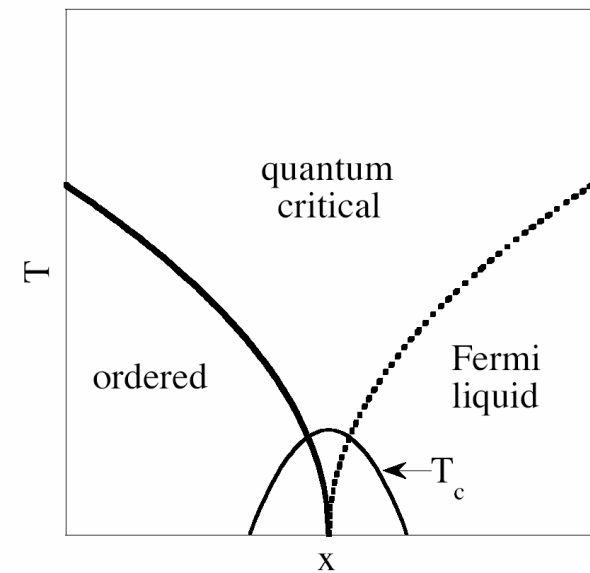
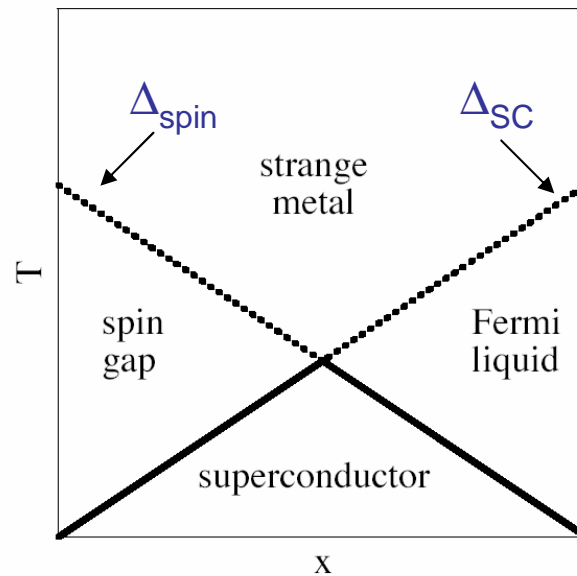
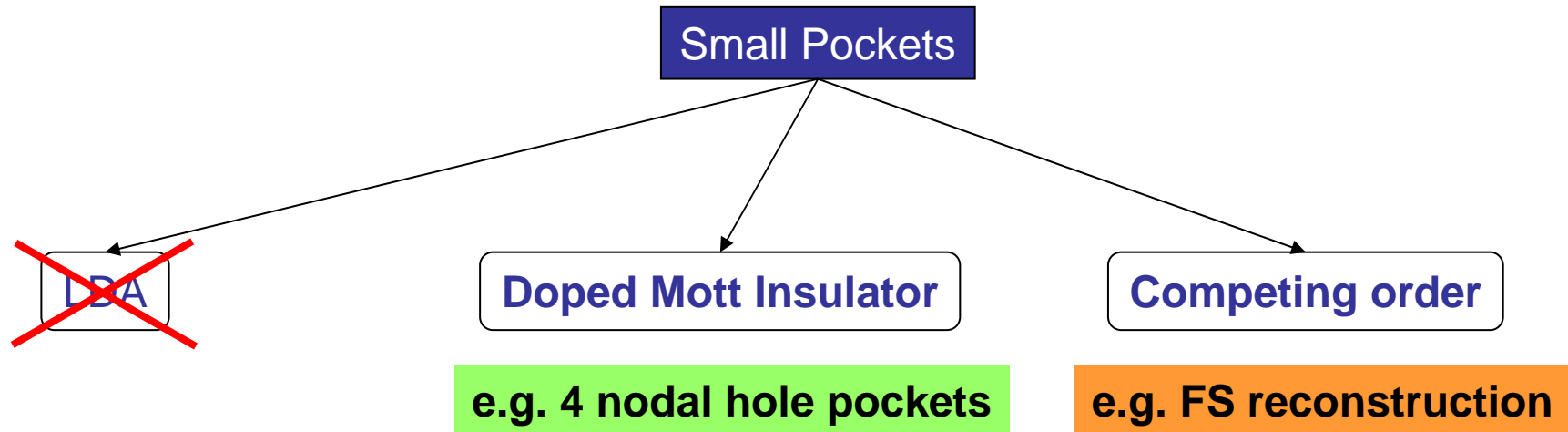

Doped Mott insulator scenario

four-nodal hole pockets e.g. doped Mott insulator

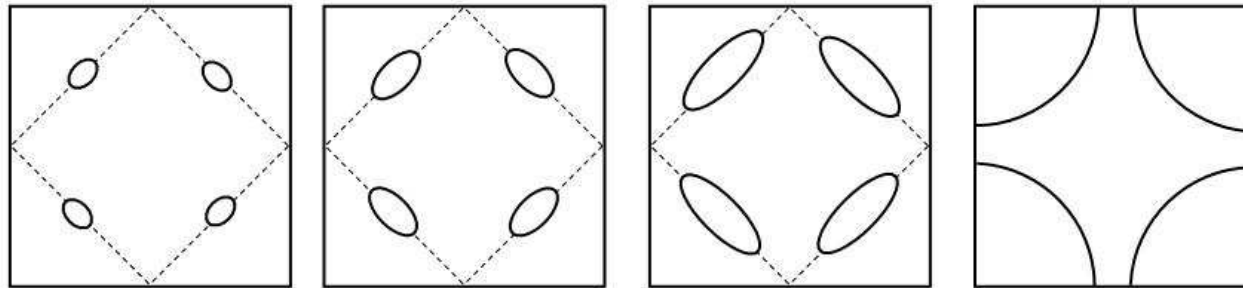

ARPES in Na-CCOC

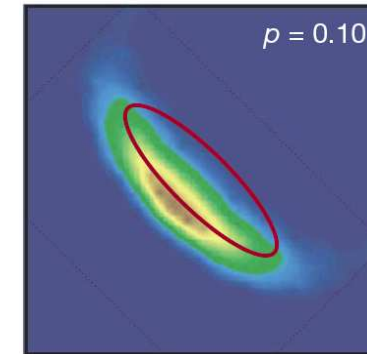

K. Shen *et al.*, Science (2005)

BUT • Negative Hall effect (electron like)

• Luttinger theorem for 2D FS:

$$n = \frac{2A_k}{(2\pi)^2} = \frac{F}{\phi_0}$$



$F = 530 \text{ T} \Rightarrow 0.15$ carriers per planar Cu atom !!! (0.1)

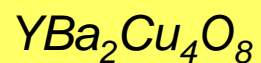

$F = 660 \text{ T} \Rightarrow n = 0.19$ carriers per planar Cu atom !!! (0.14)

Scenarios for the Fermi surface

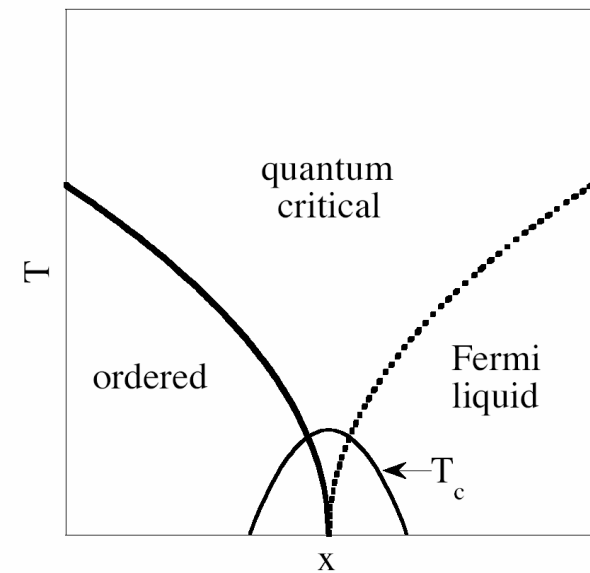
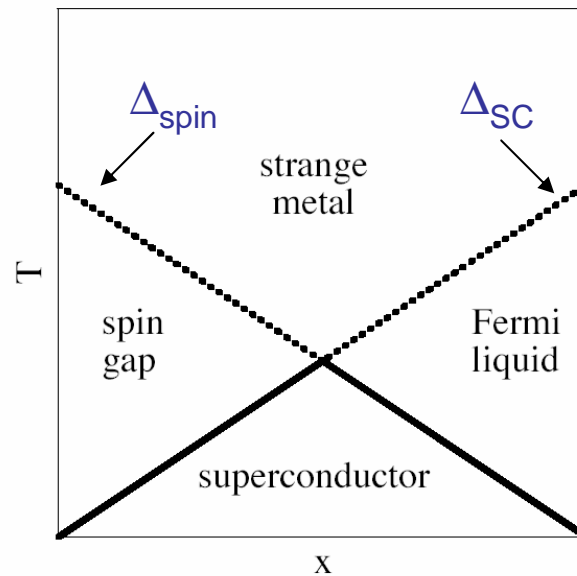
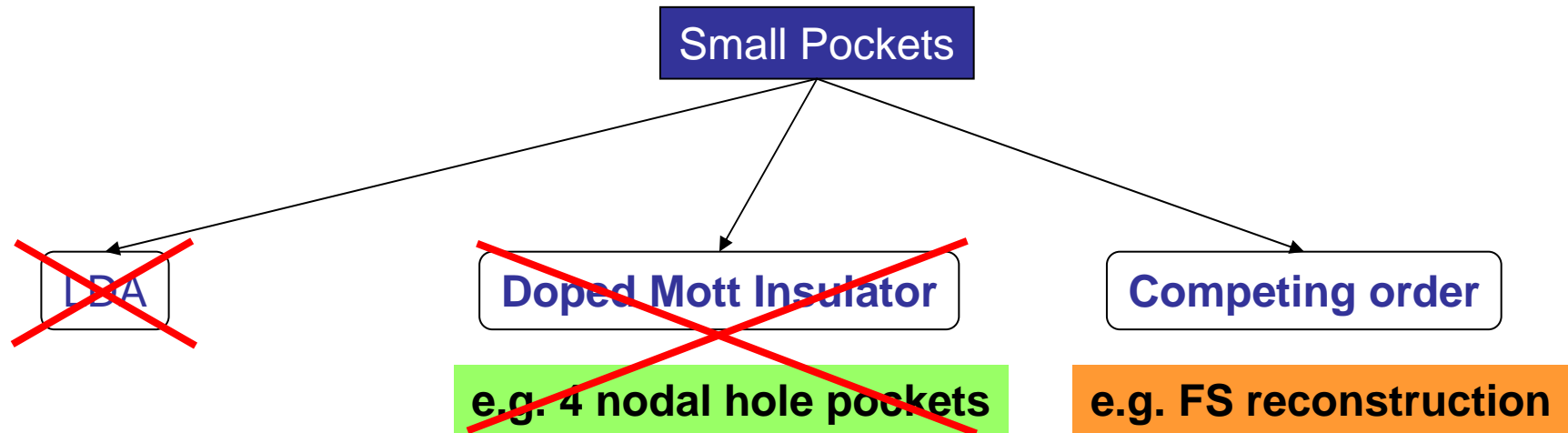

Fermi surface reconstruction

AF / d-DW order

(Rice, Chakravarty)

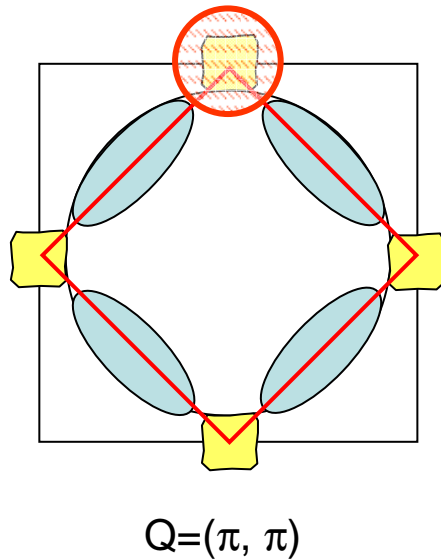

(Field induced) SDW

(Sachdev, Harrison)

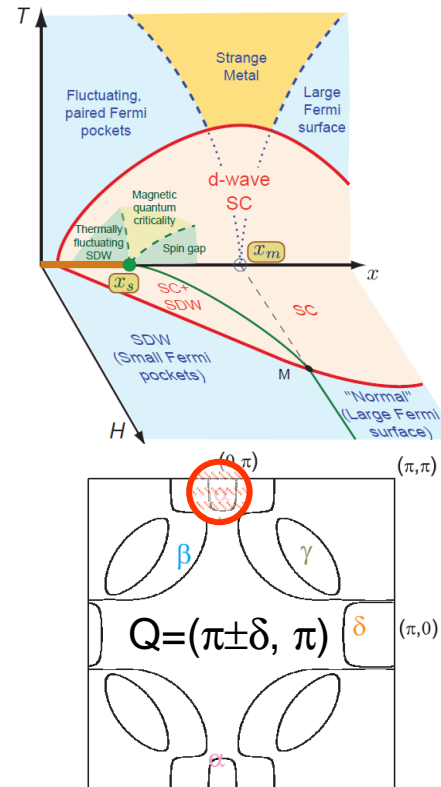

Stripes

(Millis and Norman, Vojta)

CDW / SDW

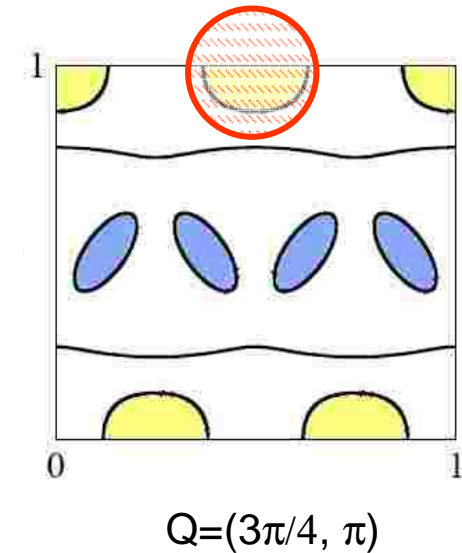

Fermi surface reconstruction scenarios \Rightarrow electron pocket at the anti-node

Outline

- Introduction to quantum oscillations
- Quantum oscillations on both sides of the phase diagram
- **The case for an electron pocket**
- Cartography of the electron pocket
- Fermi surface reconstruction scenarios

Hall and Seebeck coefficients

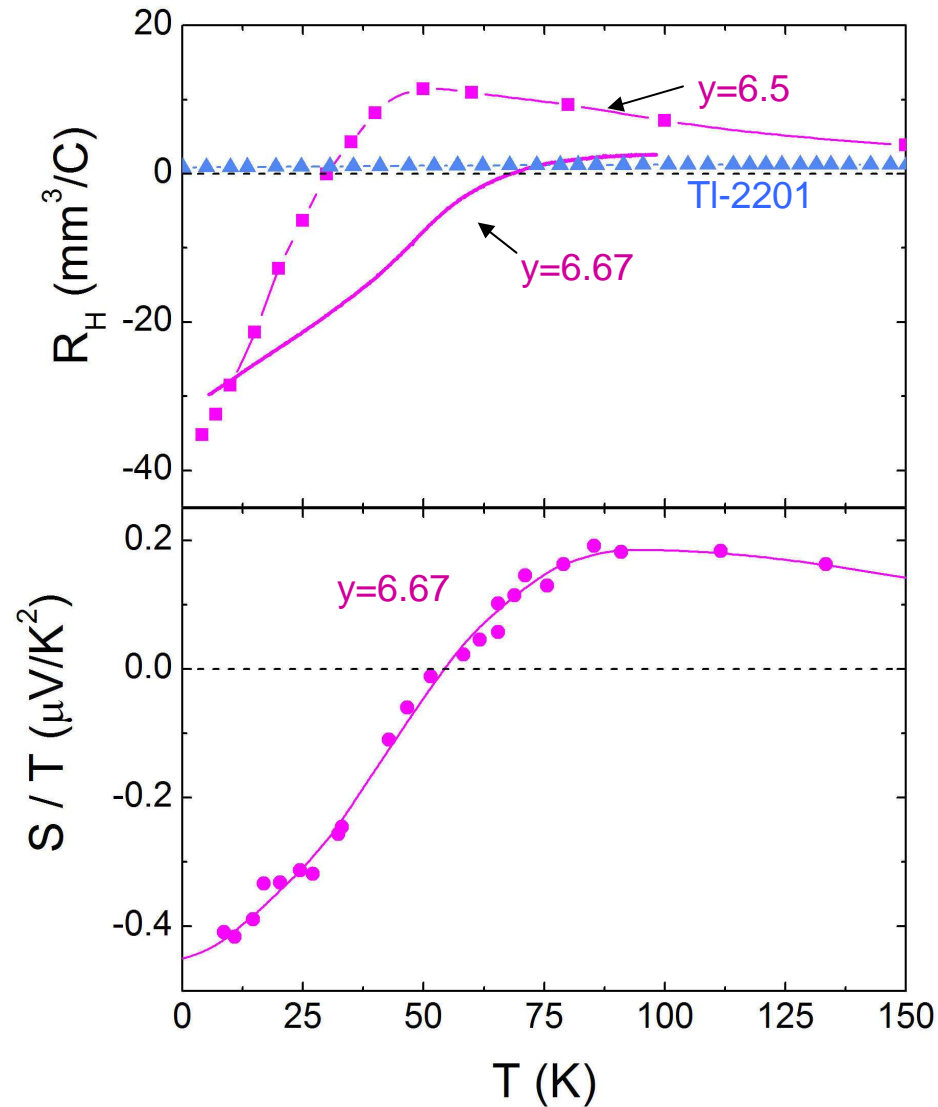

Hall

LeBoeuf et al,
Nature'07

Seebeck

Chang et al,
PRL'10

Two bands model in Y248

$$\rho_{xx}(H) = \frac{(\sigma_h + \sigma_e) + \sigma_h \sigma_e (\sigma_h R_h^2 + \sigma_e R_e^2) H^2}{(\sigma_h + \sigma_e)^2 + \sigma_h^2 \sigma_e^2 (R_h - R_e)^2 H^2}$$

$$\rho_{xy}(H) = \frac{\sigma_h^2 R_h - \sigma_e^2 R_e - \sigma_h^2 \sigma_e^2 R_h R_e (R_h - R_e) H^2}{(\sigma_h + \sigma_e)^2 + \sigma_h^2 \sigma_e^2 (R_h - R_e)^2 H^2} H$$

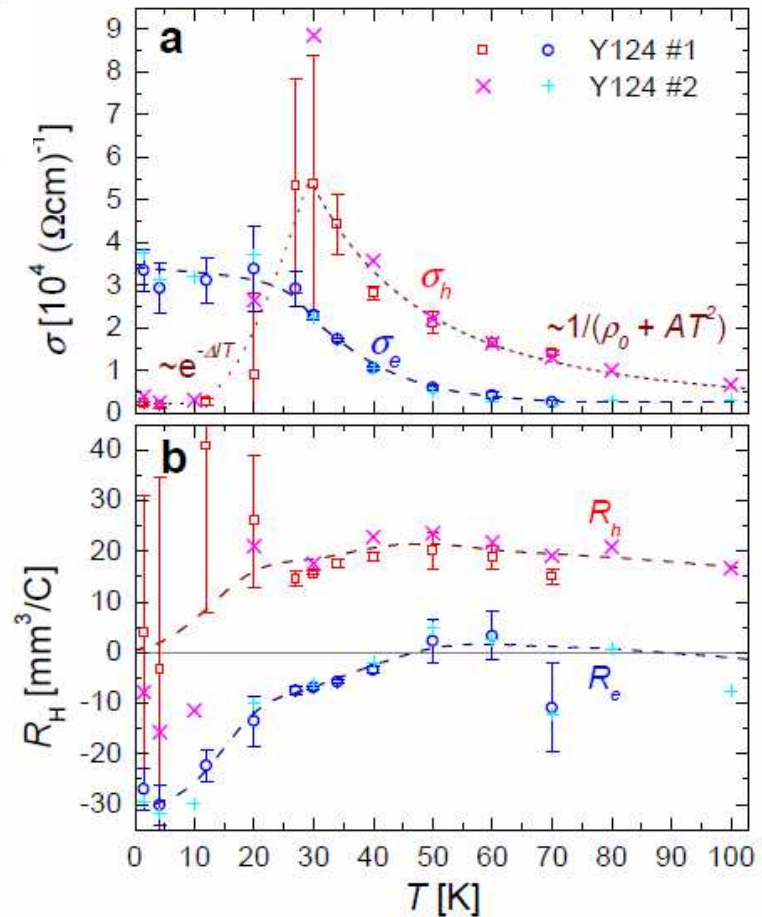
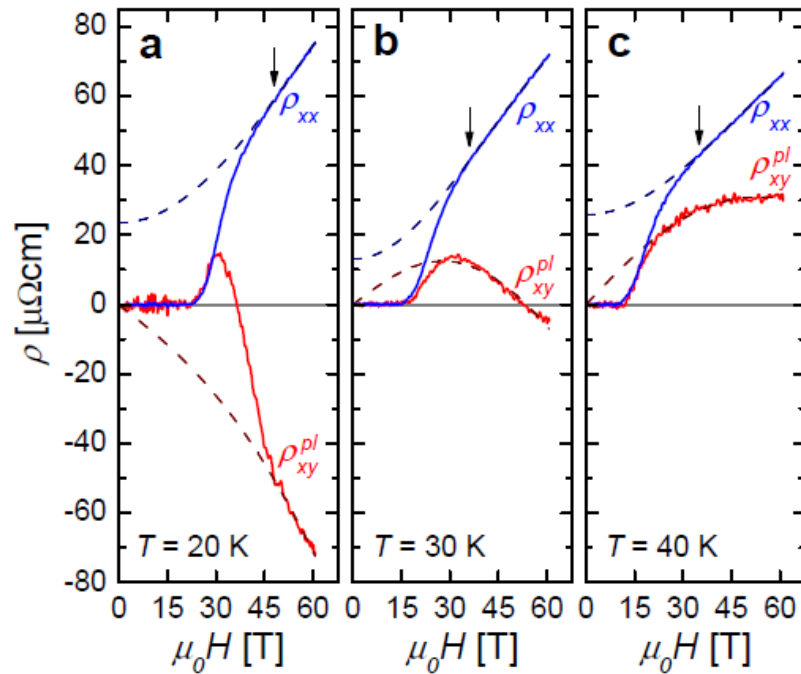

π -shift in R_{xx} and R_{xy}

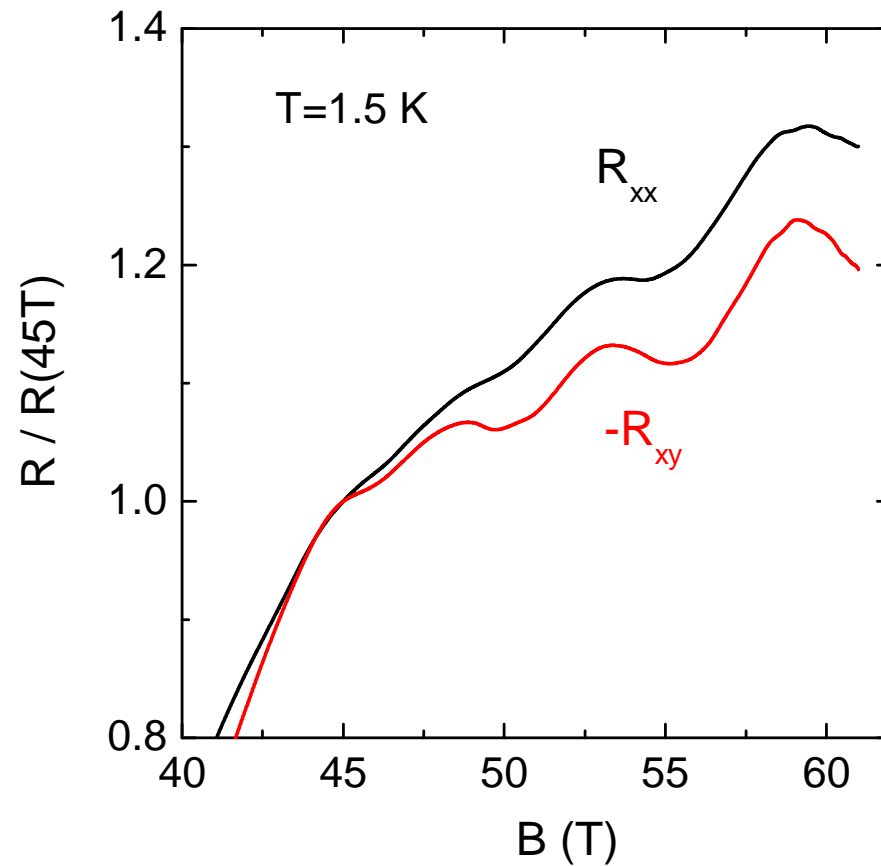
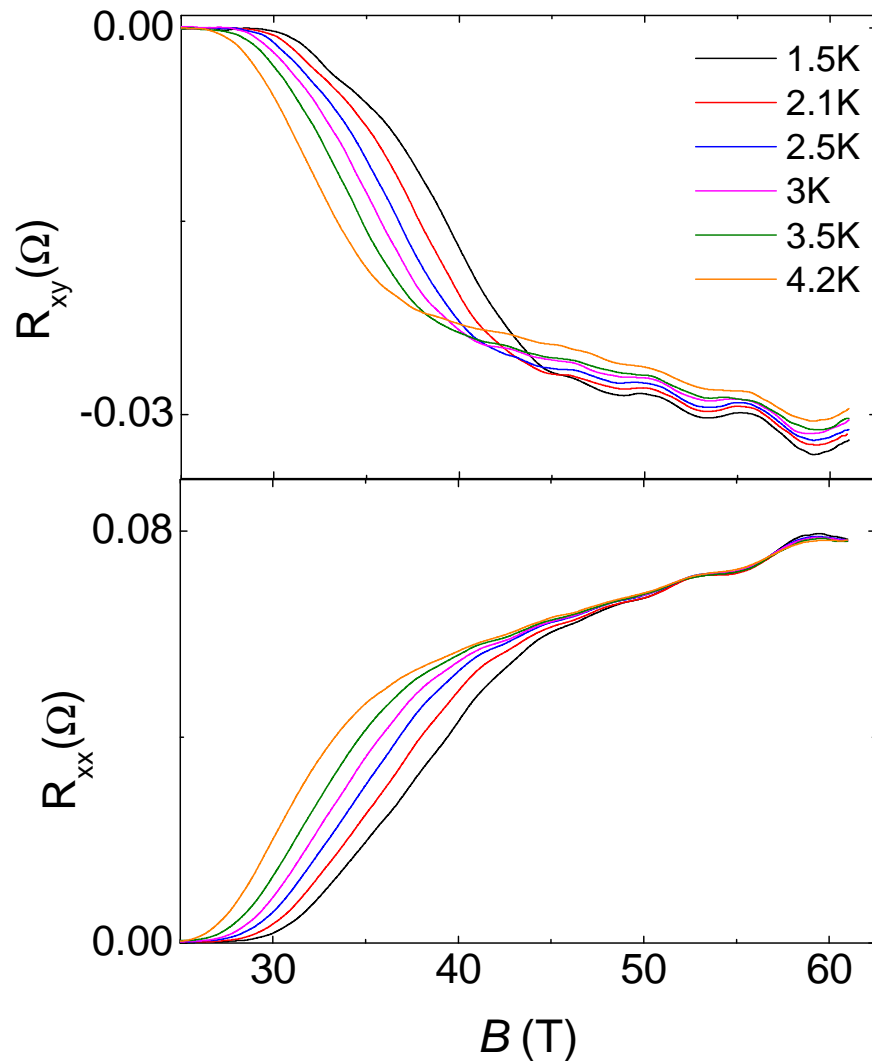

Outline

- Introduction to quantum oscillations
- Quantum oscillations on both sides of the phase diagram
- The case for an electron pocket
- **Cartography of the electron pocket**
- Fermi surface reconstruction scenarios

Angle-dependence of QO in $YBa_2Cu_3O_{6.6}$

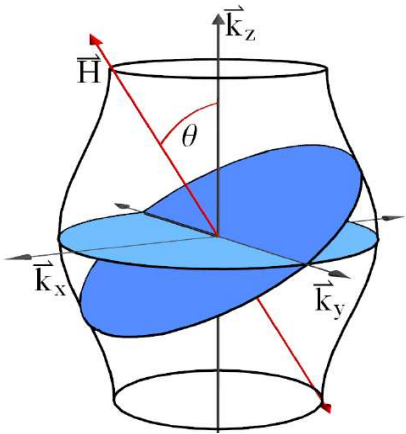

$$\rho_{osc}/\rho_o = AR_T R_D R_s \sin\left(2\pi\left(\frac{F}{H \cos\theta} - \gamma\right)\right) J_0\left(2\pi\frac{\Delta F}{H \cos\theta} J_0(k_F c \tan\theta)\right)$$

NO F_β frequency !

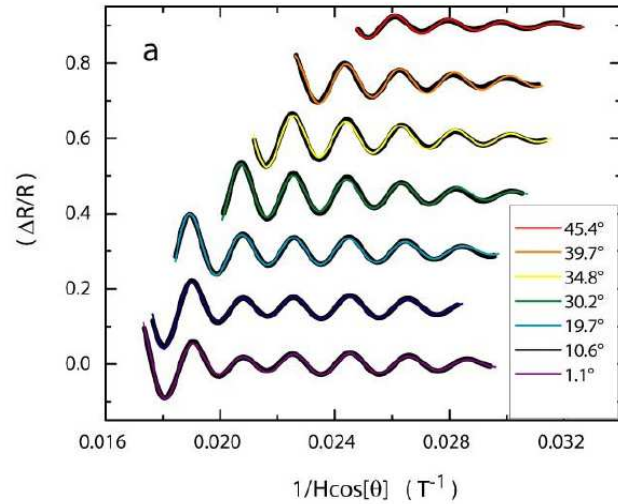
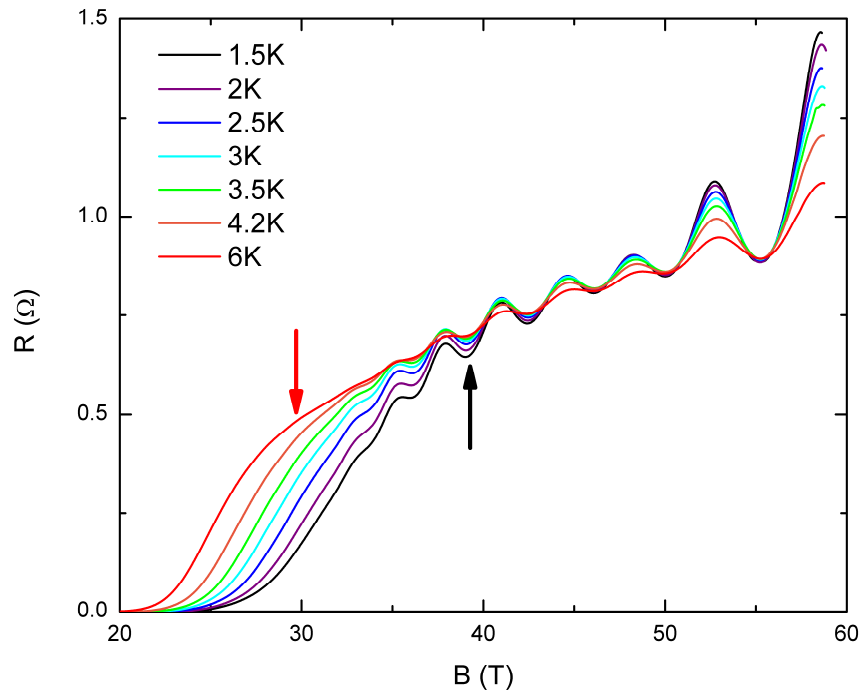

Angle dependence

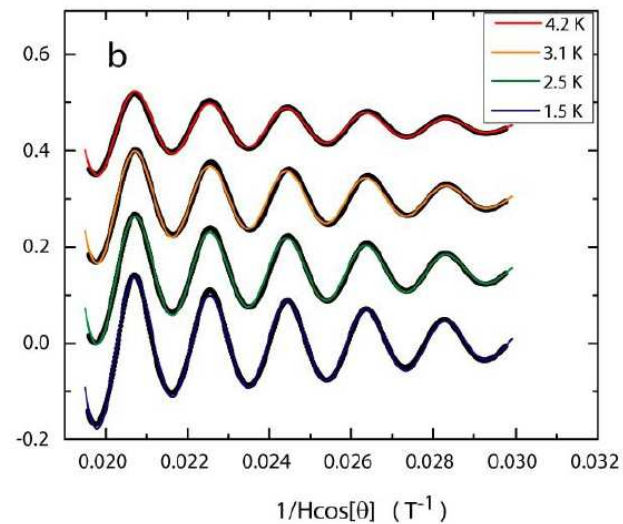

Temperature dependence

Angle-dependence of QO in $YBa_2Cu_3O_{6.6}$

	Surface 1	Surface 2
$F(T)$	478	526
$\Delta F(T)$	37.7	3.5
m^*/m_e	1.5	1.7
gm_s/m_e	2.1	3.2
$T_D(K)$	5.8	6.4
γ	3.5	1.1
A	13	18.5

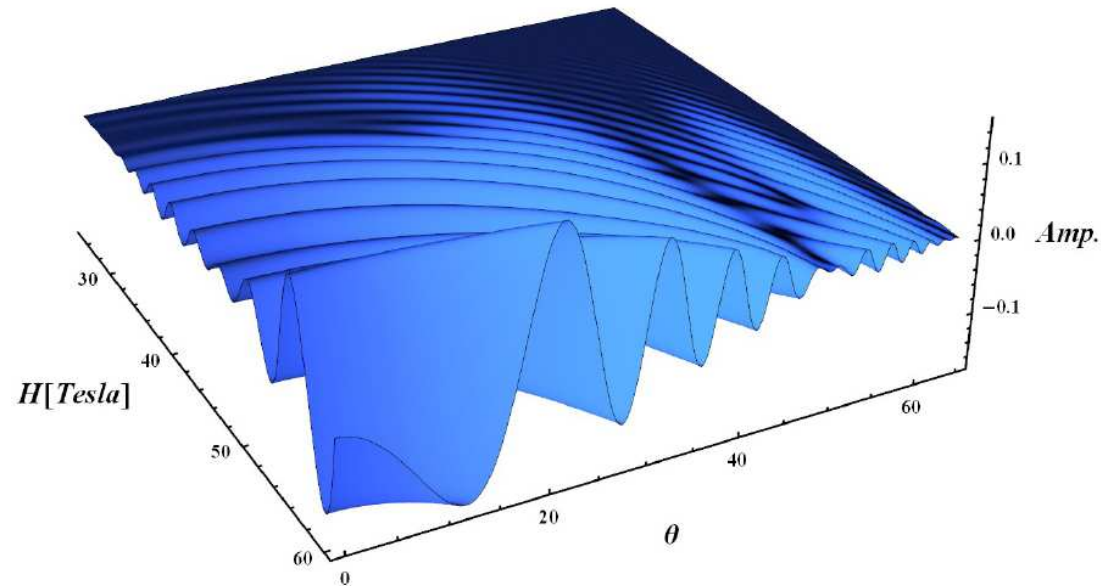
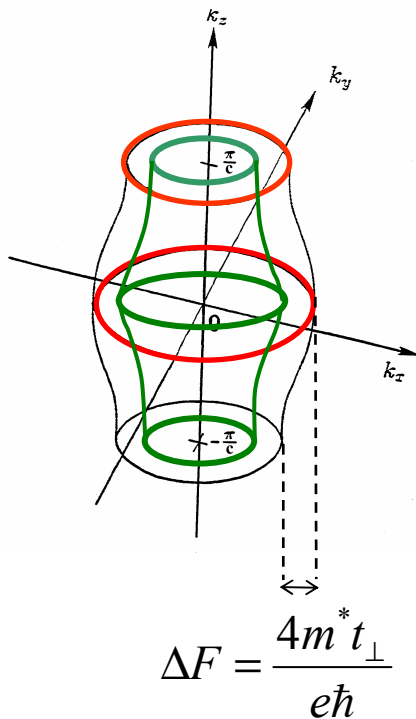

Bilayer splitting + Warping

c-axis coherence

$$\Delta F = 90 \text{ T}$$



$$t_{\perp} \sim 1.3 \text{ meV (15 K)}$$

Spin zero phenomena

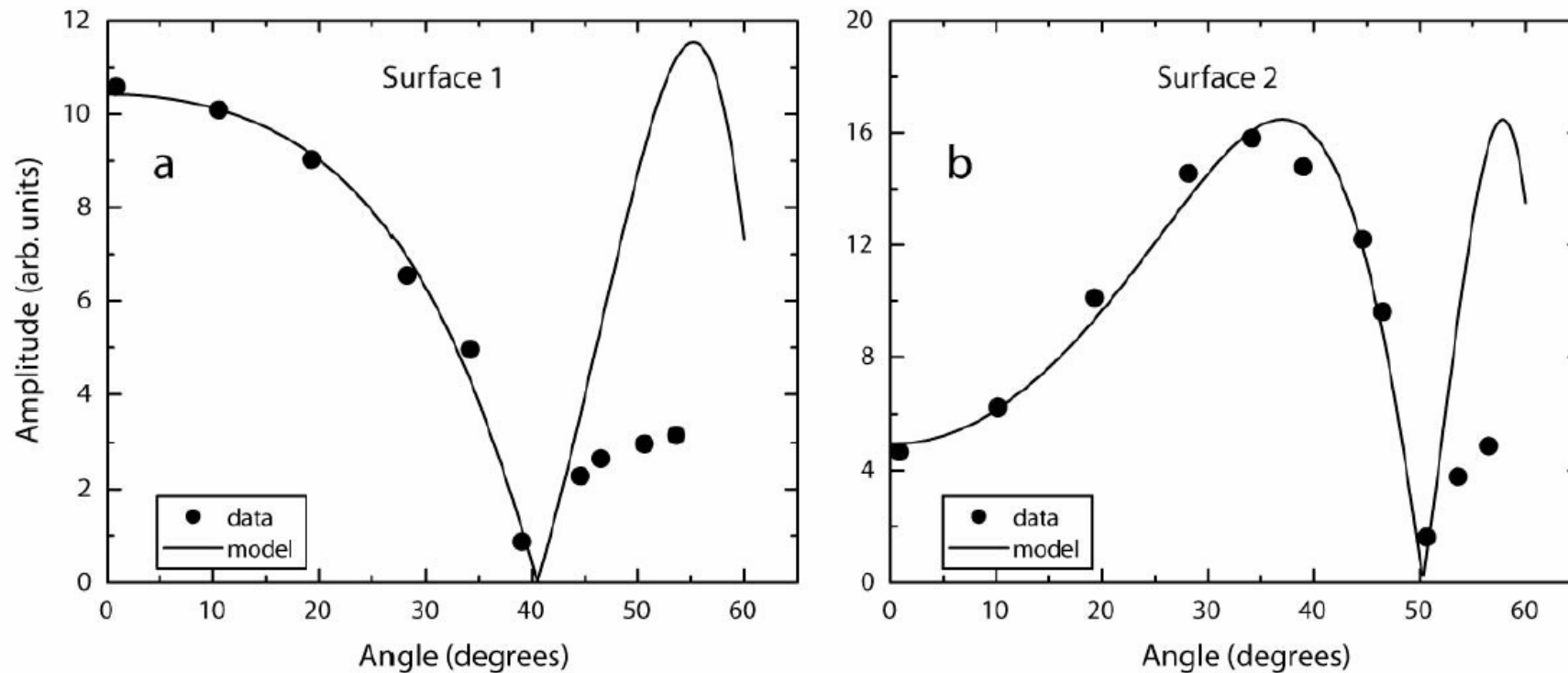

⇒ Staggered moments have a large component along the field direction
Not compatible with a pure AF scenario !

Location of the electron pocket

c-axis Resistivity in YBCO

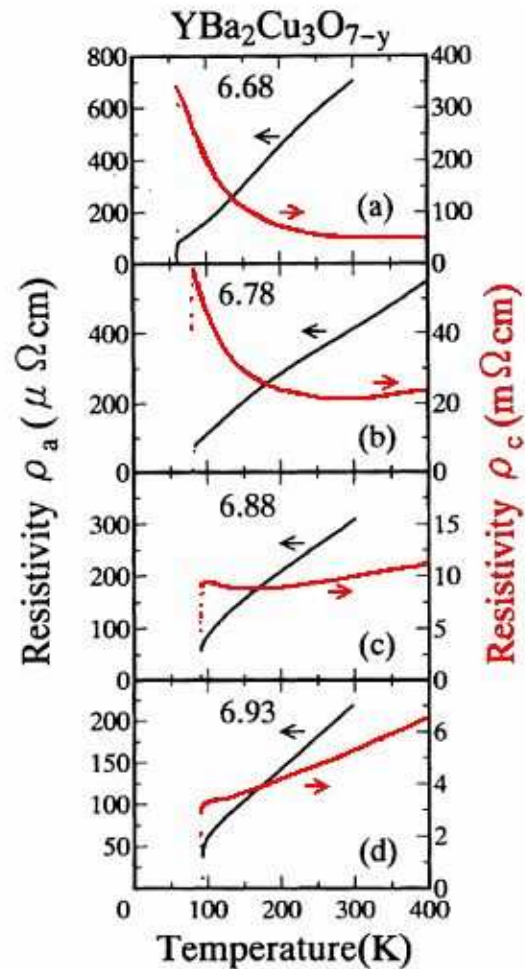

K. Takenaka et al, PRB'94

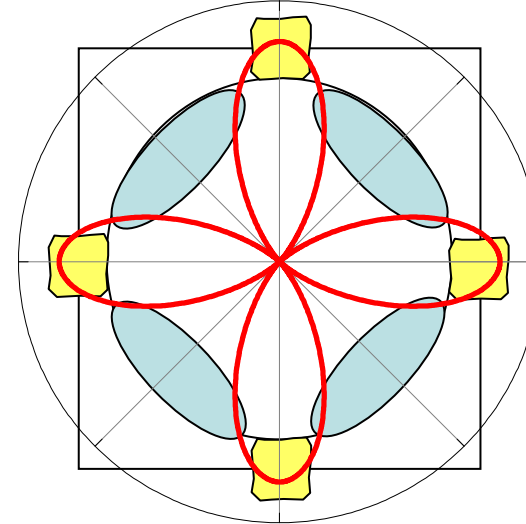

$$t_{\perp}(k) = \frac{t_{\perp}}{4} [\cos(k_x a) - \cos(k_y a)]^2$$

$$\sigma_c = \frac{4e^2 c t_{\perp}^2 m^* \tau_c}{\pi \hbar^4}$$

Scenario: Charge confinement in the CuO_2 plane ($\rho_c \rightarrow \infty$ as $T \rightarrow 0$) ?

c-axis magnetoresistance in UD YBCO

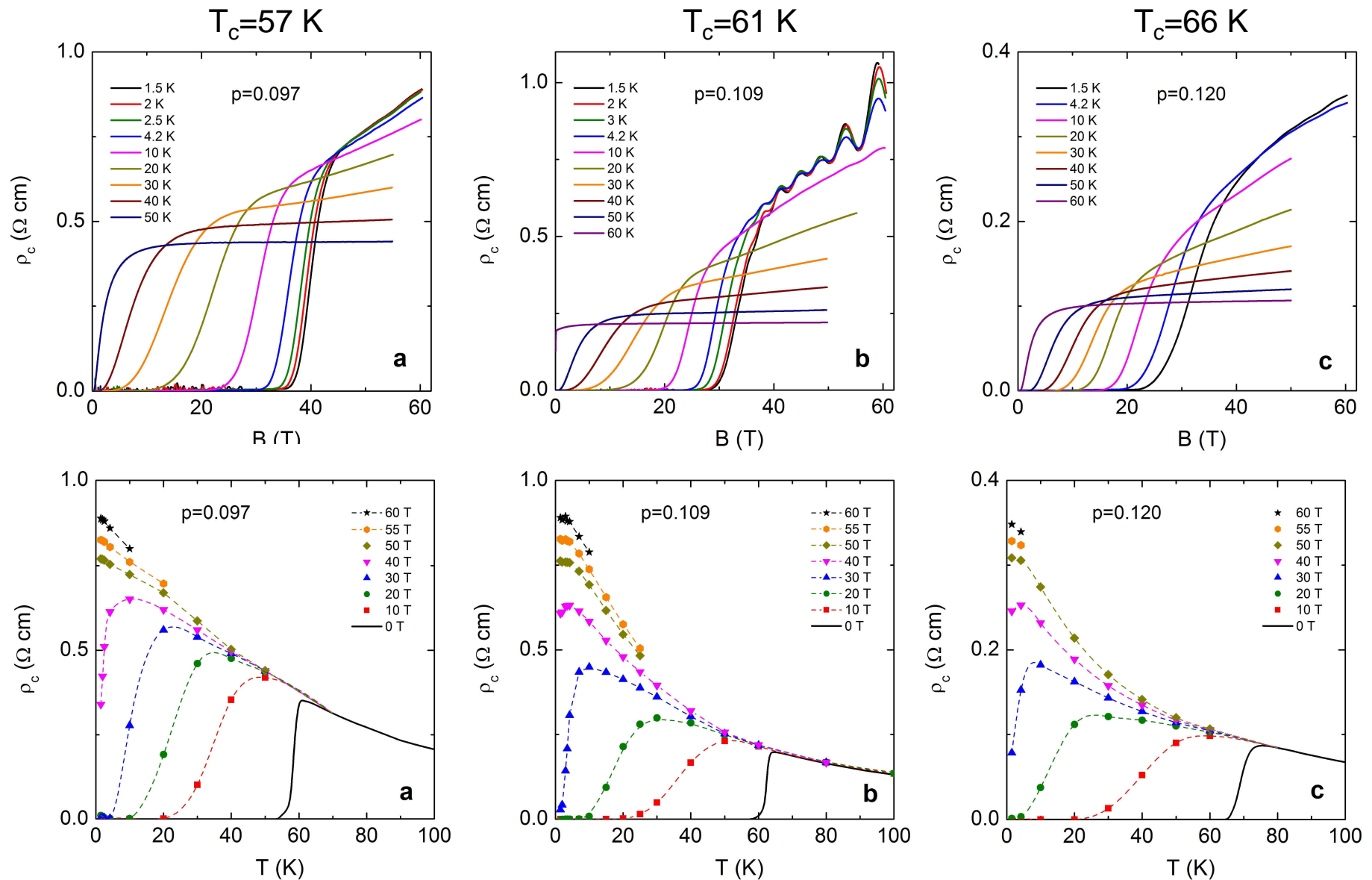

Extrapolation of the magnetoresistance

Two-band model:
$$\rho(B) = \frac{(\mu_h + \mu_e) + \mu_h \mu_e (\mu_h R_h^2 + \mu_e R_e^2) B^2}{(\mu_h + \mu_e)^2 + \mu_h^2 \mu_e^2 (R_h + R_e)^2 B^2} = \rho_0 + \frac{\alpha B^2}{1 + \beta B^2}$$

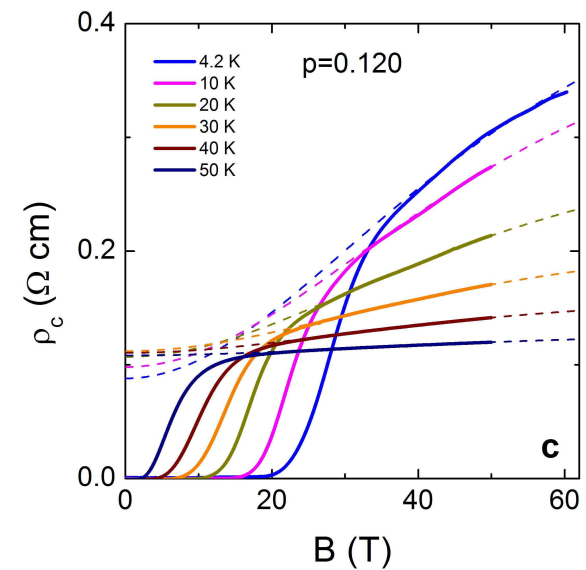
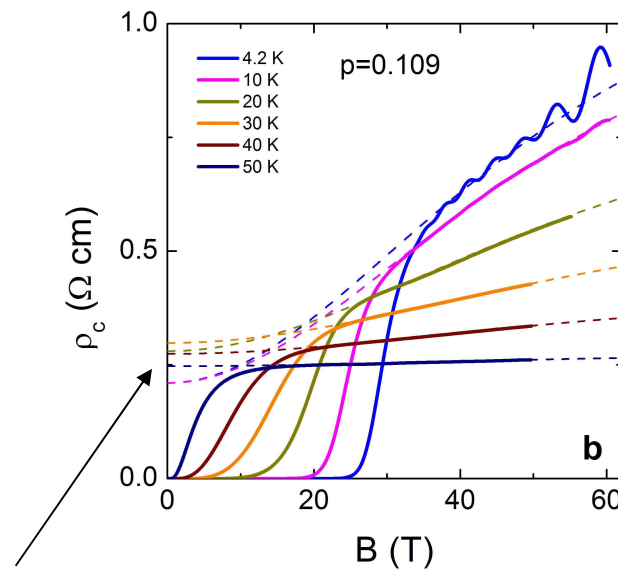
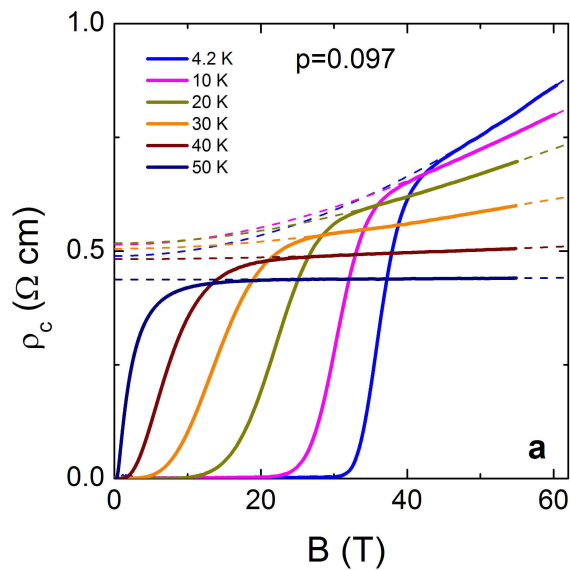

$\rho_c(0)$: extrapolated zero-field resistivity

Temperature dependence of $\rho_c(0)$

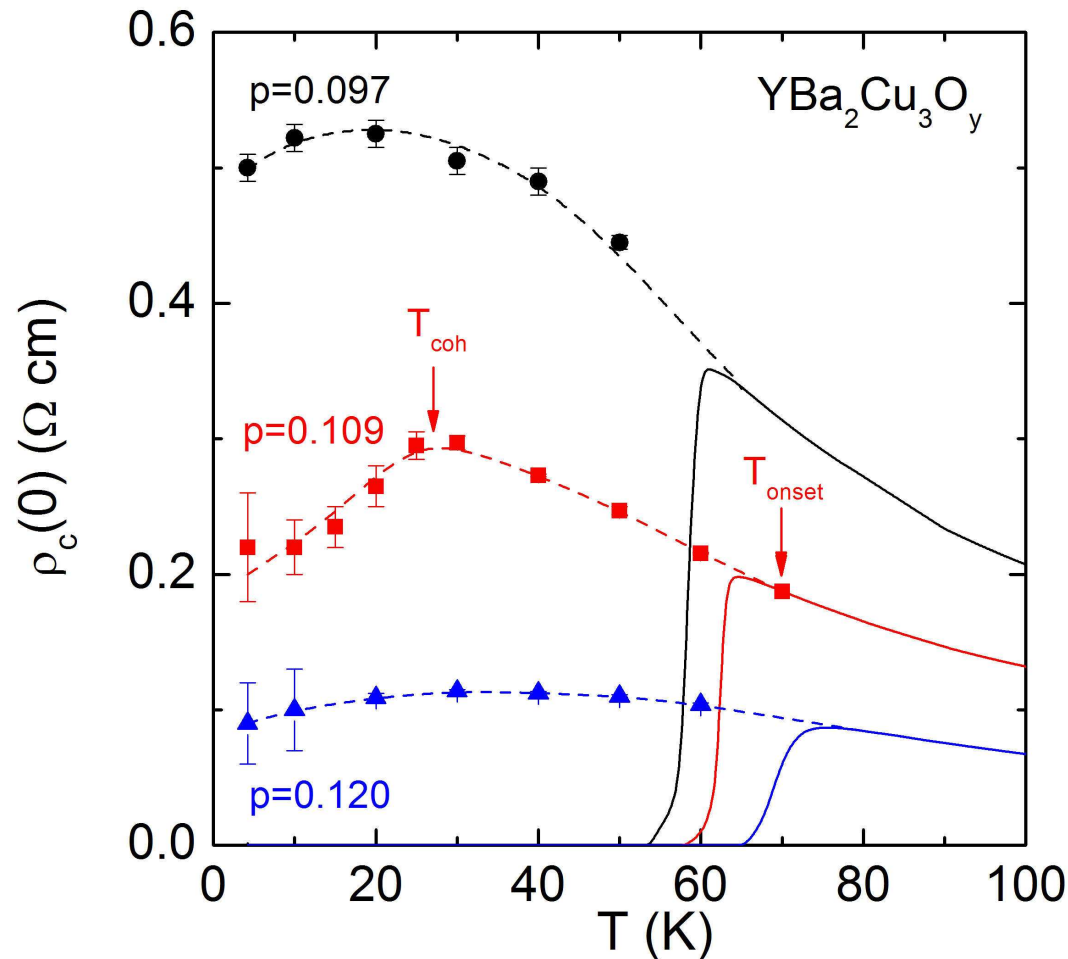

3D Fermi Surface in underdoped YBCO!

Cross-over:

Incoherence \rightarrow Coherence

$T_{\text{coh}} = 27 \pm 5$ K for $p=0.109$

Good agreement with $t_{\perp} \sim 15$ K from QO

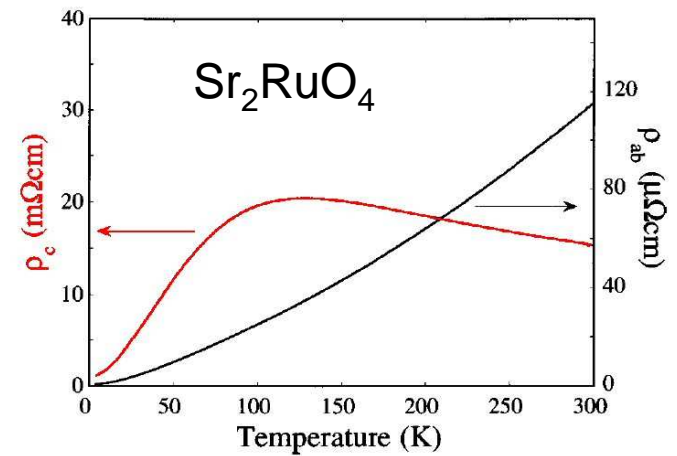

Phase diagram

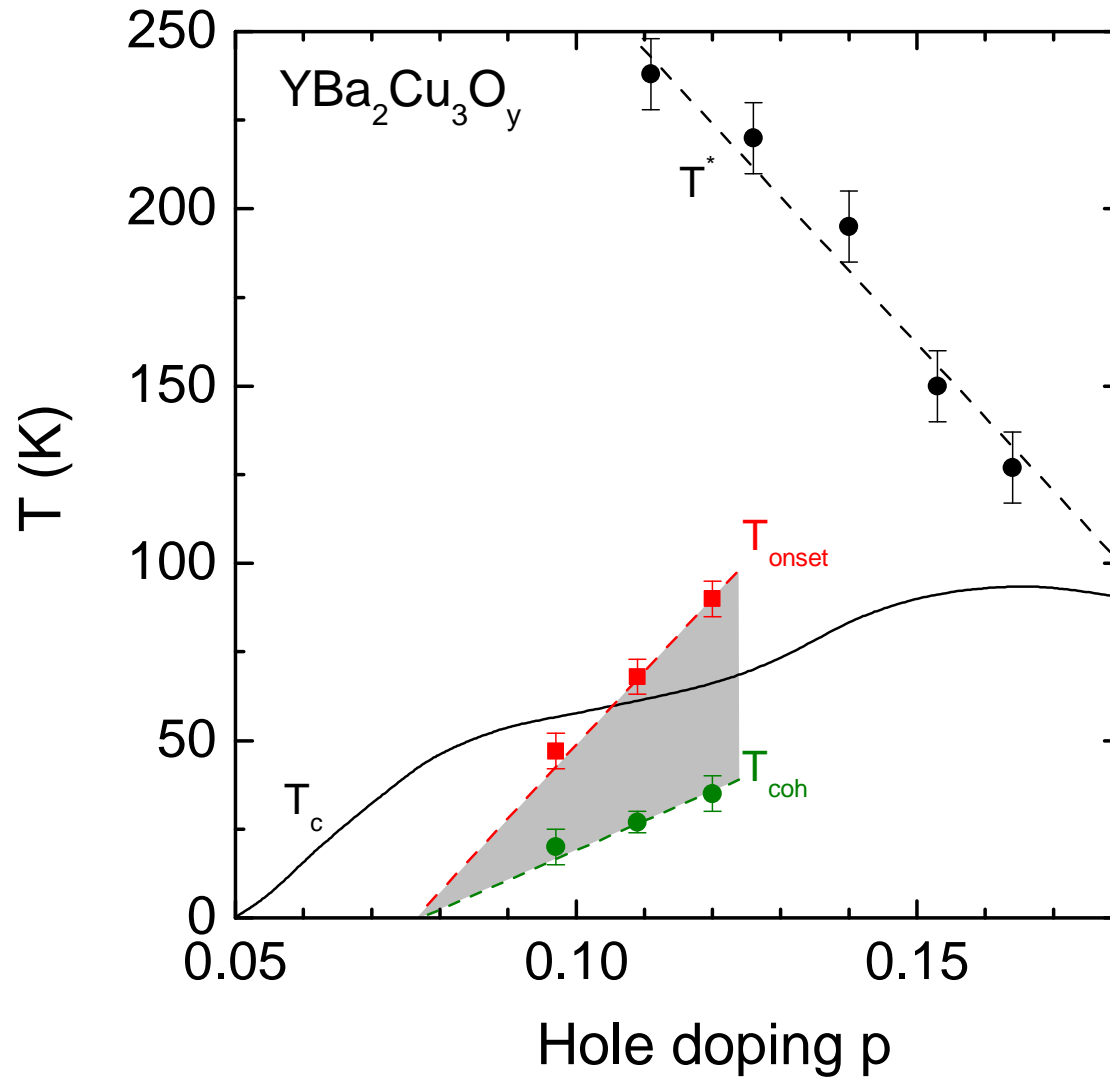

Electron pocket at the anti-node

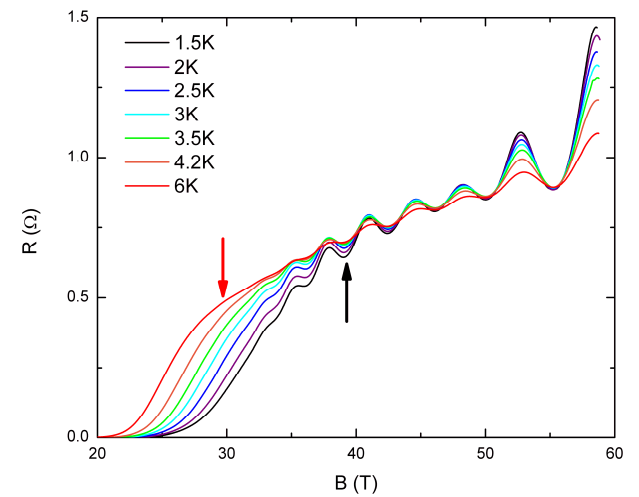
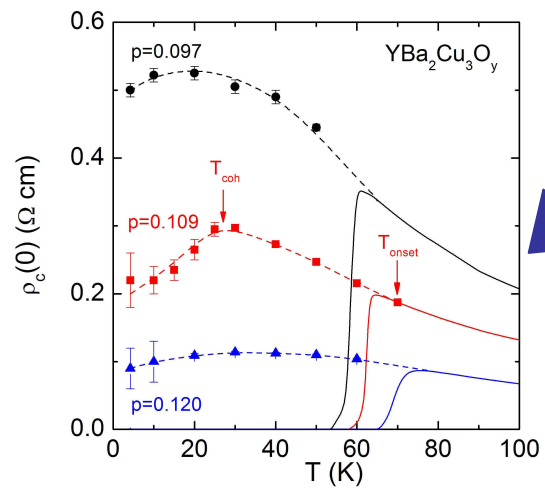
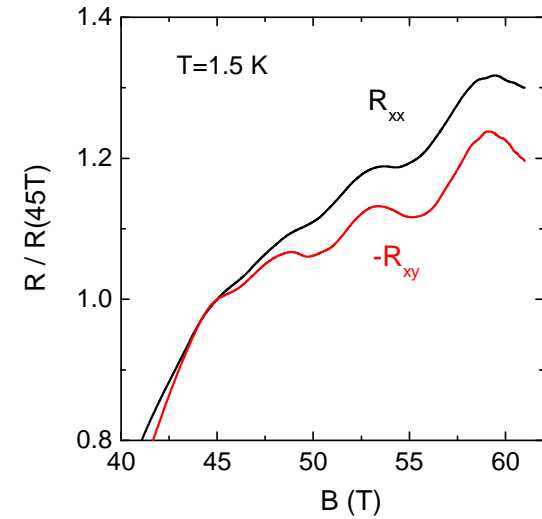
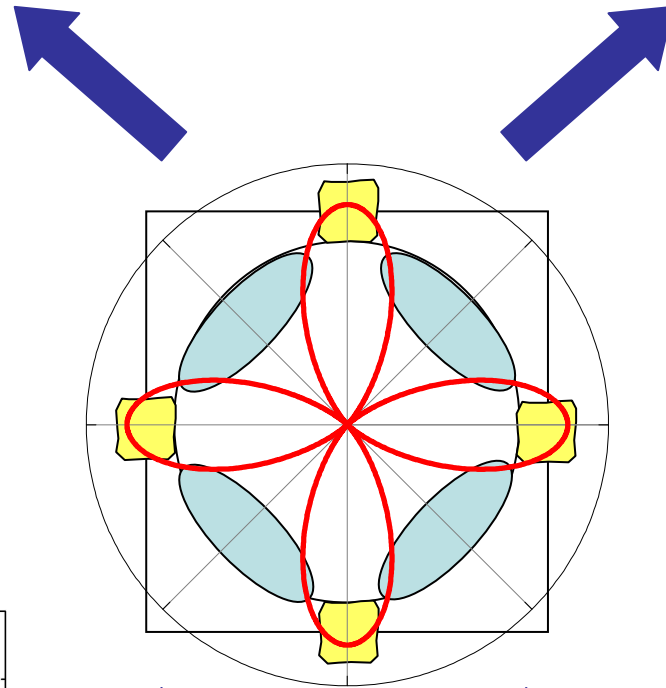
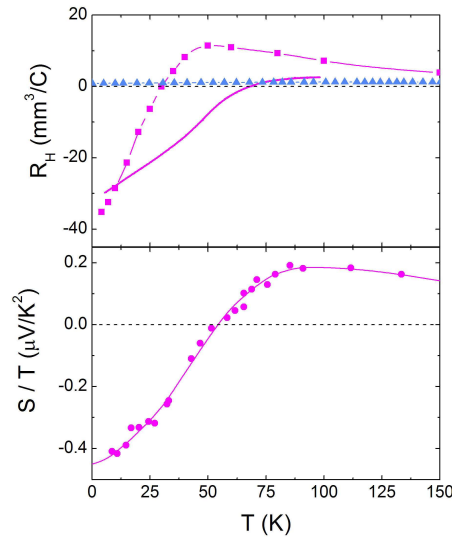

Doping dependence of QO

c-axis magnetoresistance in underdoped $\text{YBa}_2\text{Cu}_3\text{O}_y$

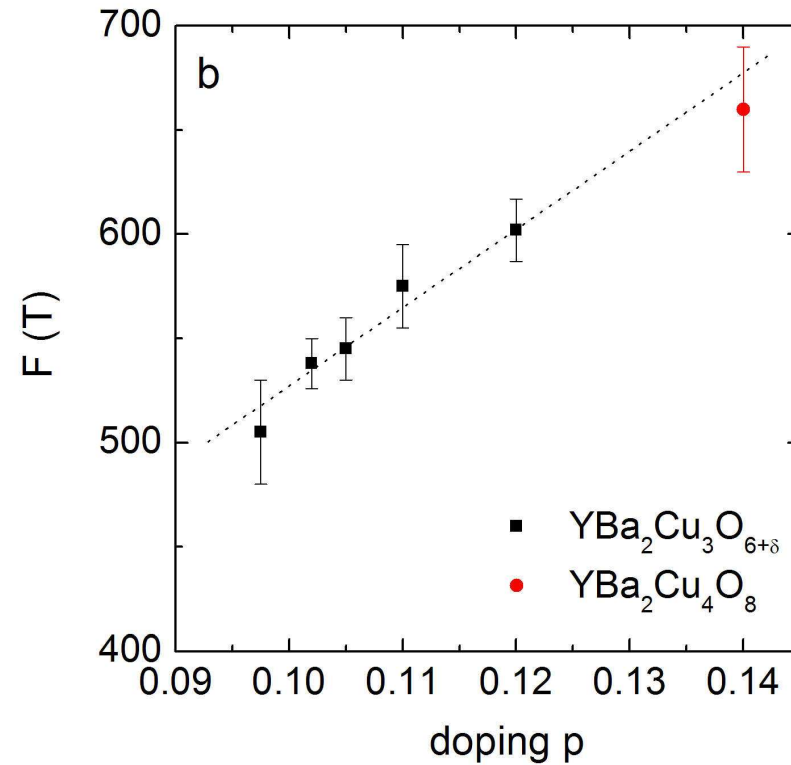
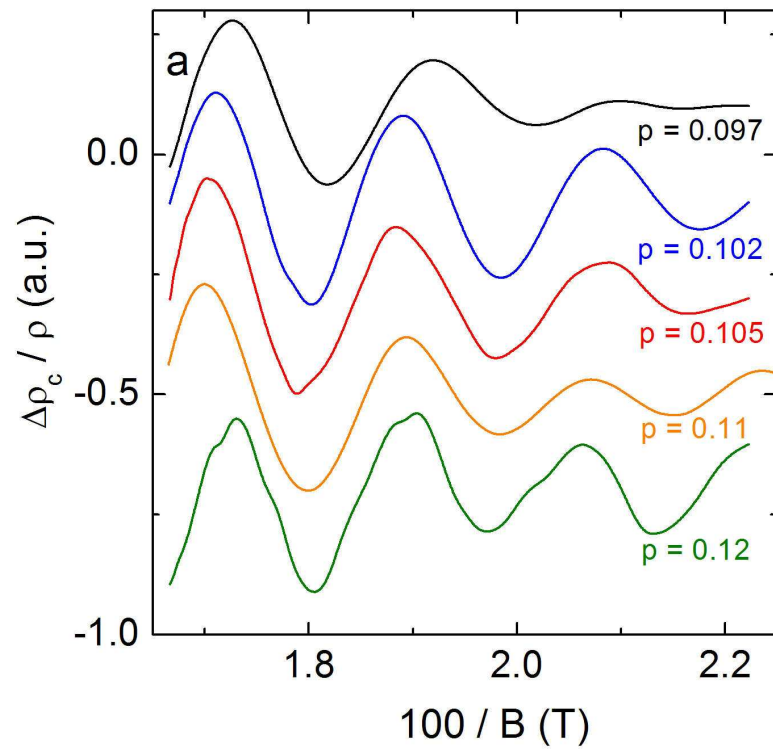

Doping dependence of the Hall effect

No sign change below $p \sim 0.08$

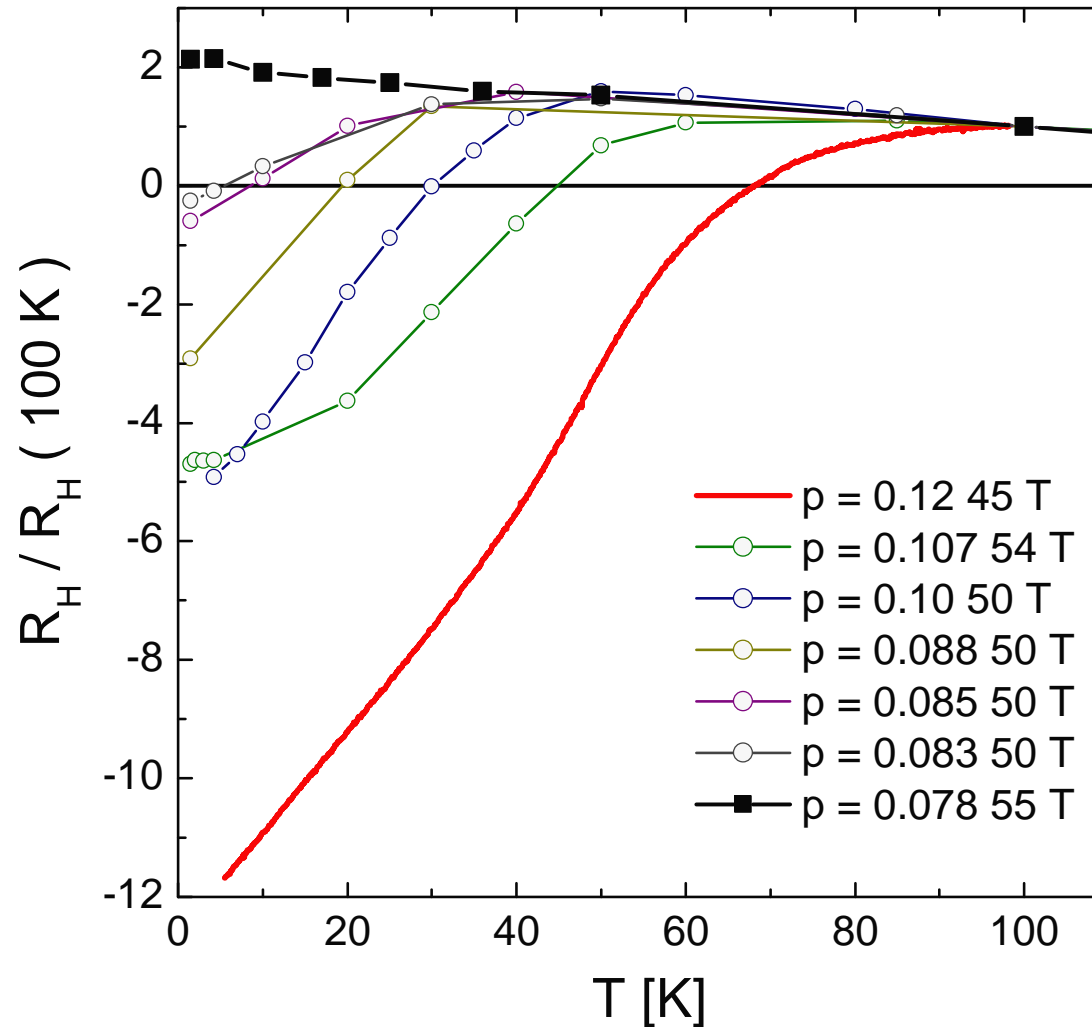

Phase diagram

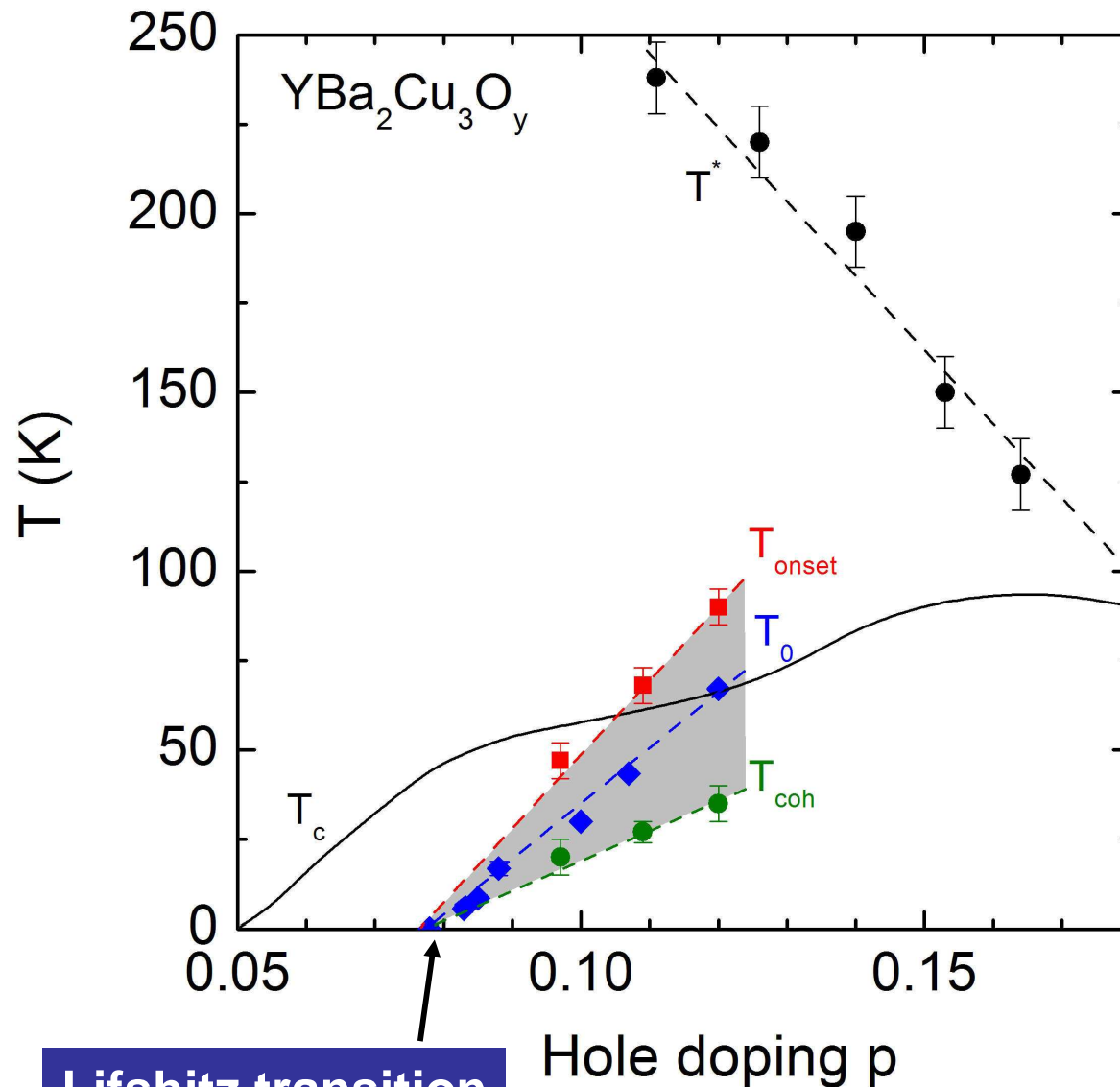

Lifshitz transition

Outline

- Introduction to quantum oscillations
- Quantum oscillations on both sides of the phase diagram
- The case for an electron pocket
- Cartography of the electron pocket
- **Fermi surface reconstruction scenarios**

Lifshitz transition

Spin density wave with (π, π) reconstruction

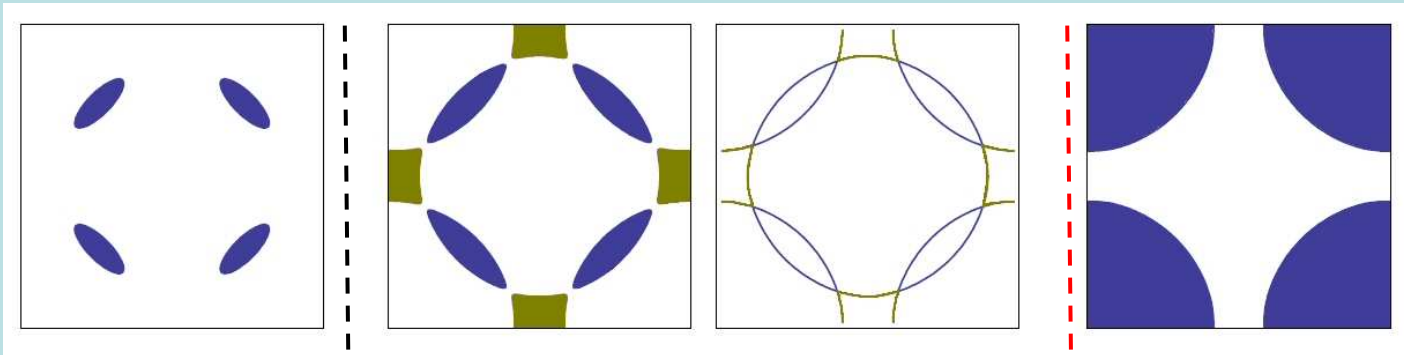

$p_L \approx 0.08$

p^*

p

Doping

Stripe scenario

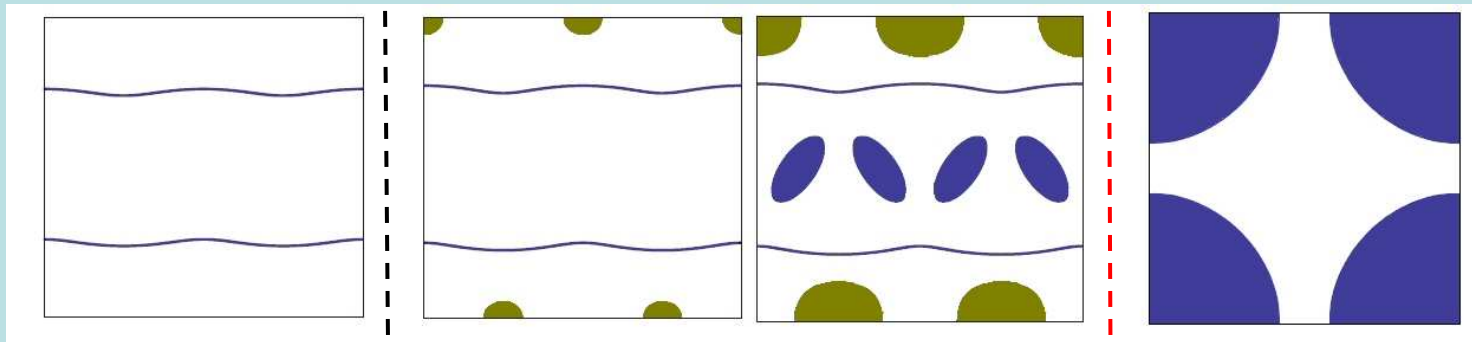

Only one QO frequency

Stripe scenario

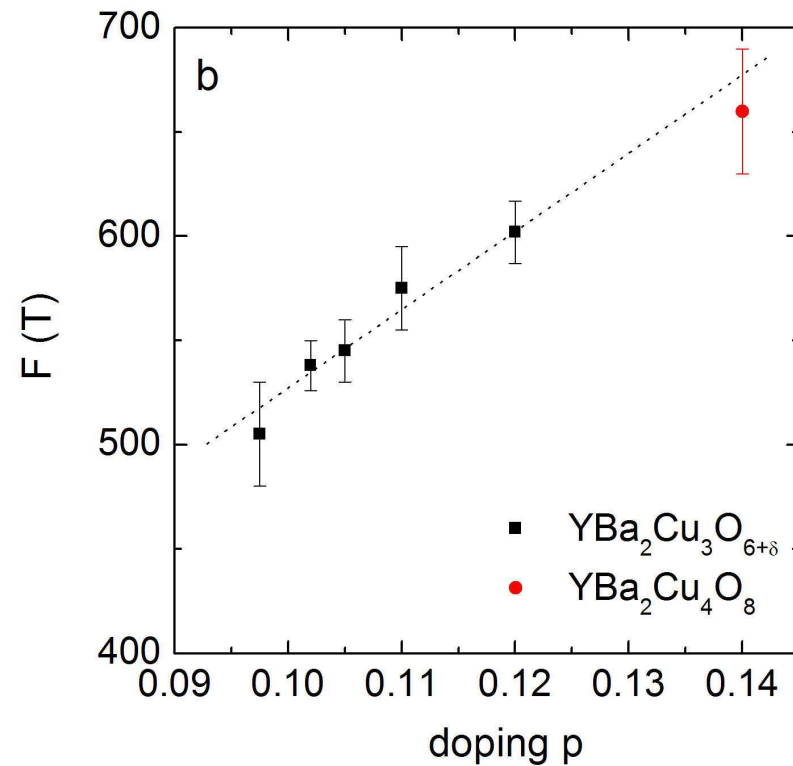
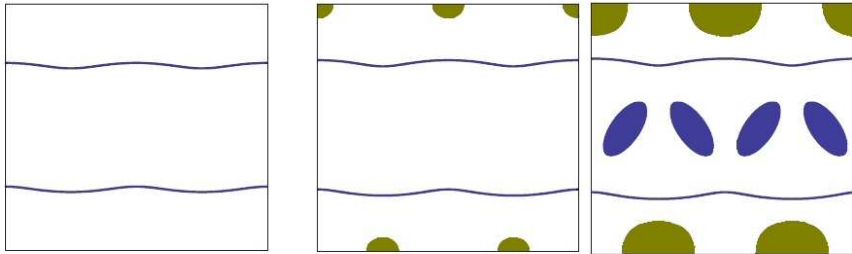

Metal-insulator cross-over

Stripe scenario

In-plane resistivity

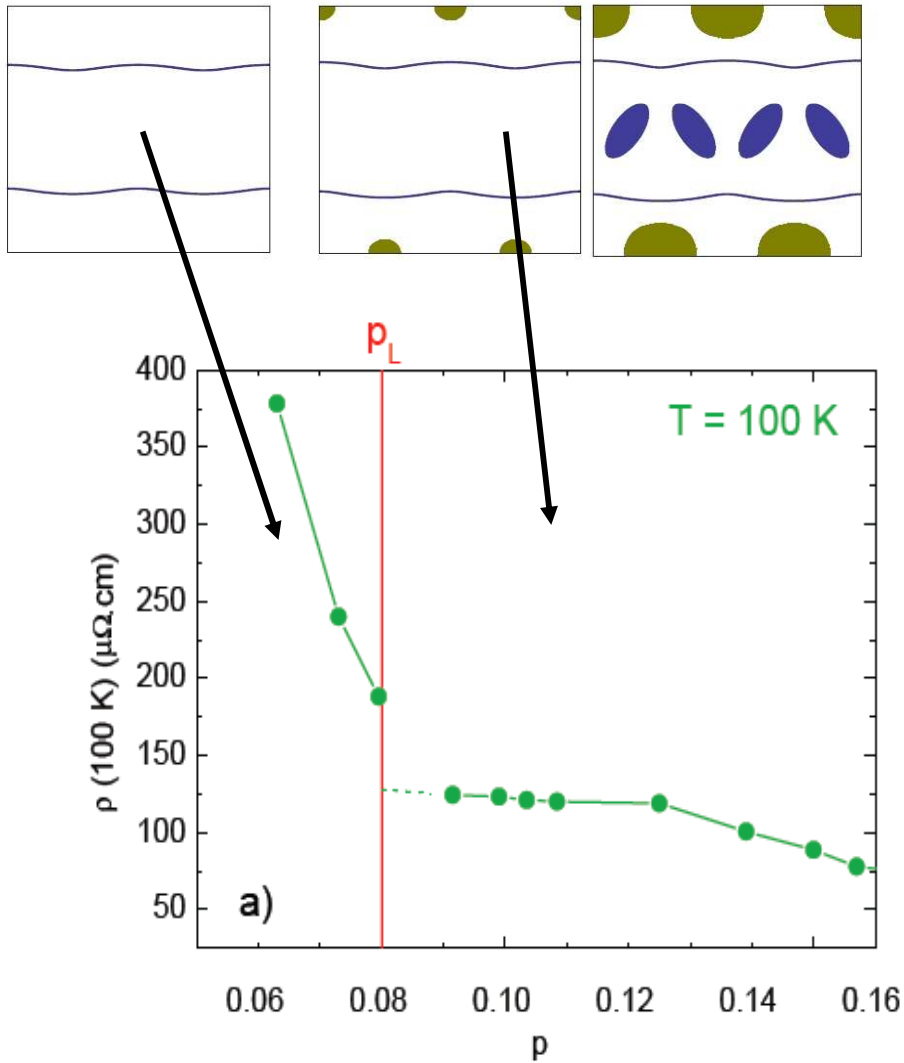

From Y. Ando et al, PRL'04

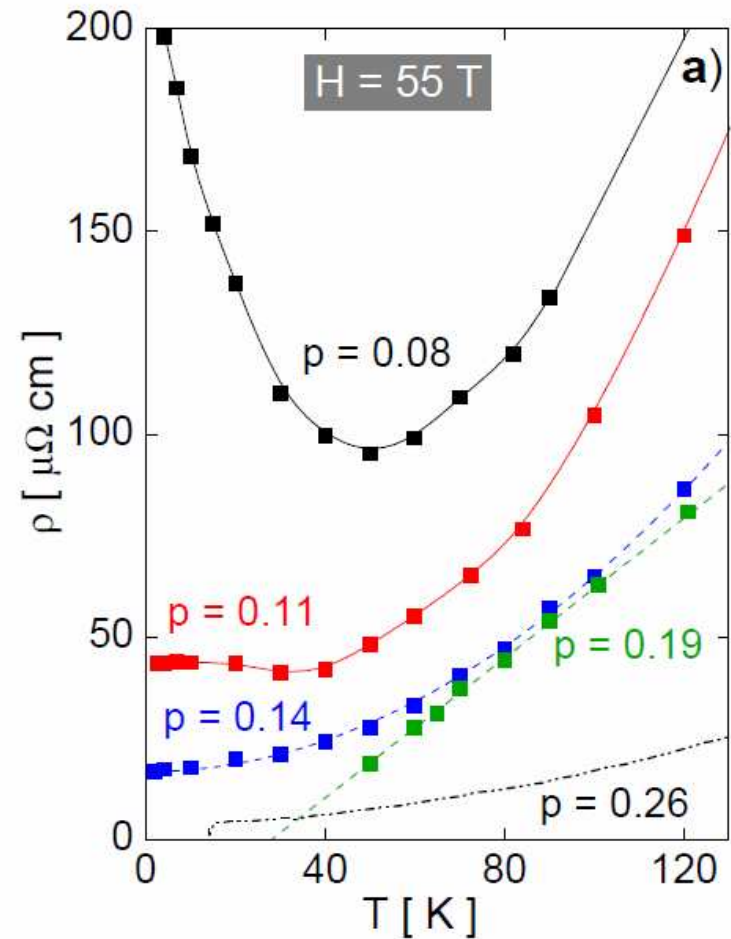

D. LeBoeuf et al, arXiv: 1009.2078

In-plane anisotropy

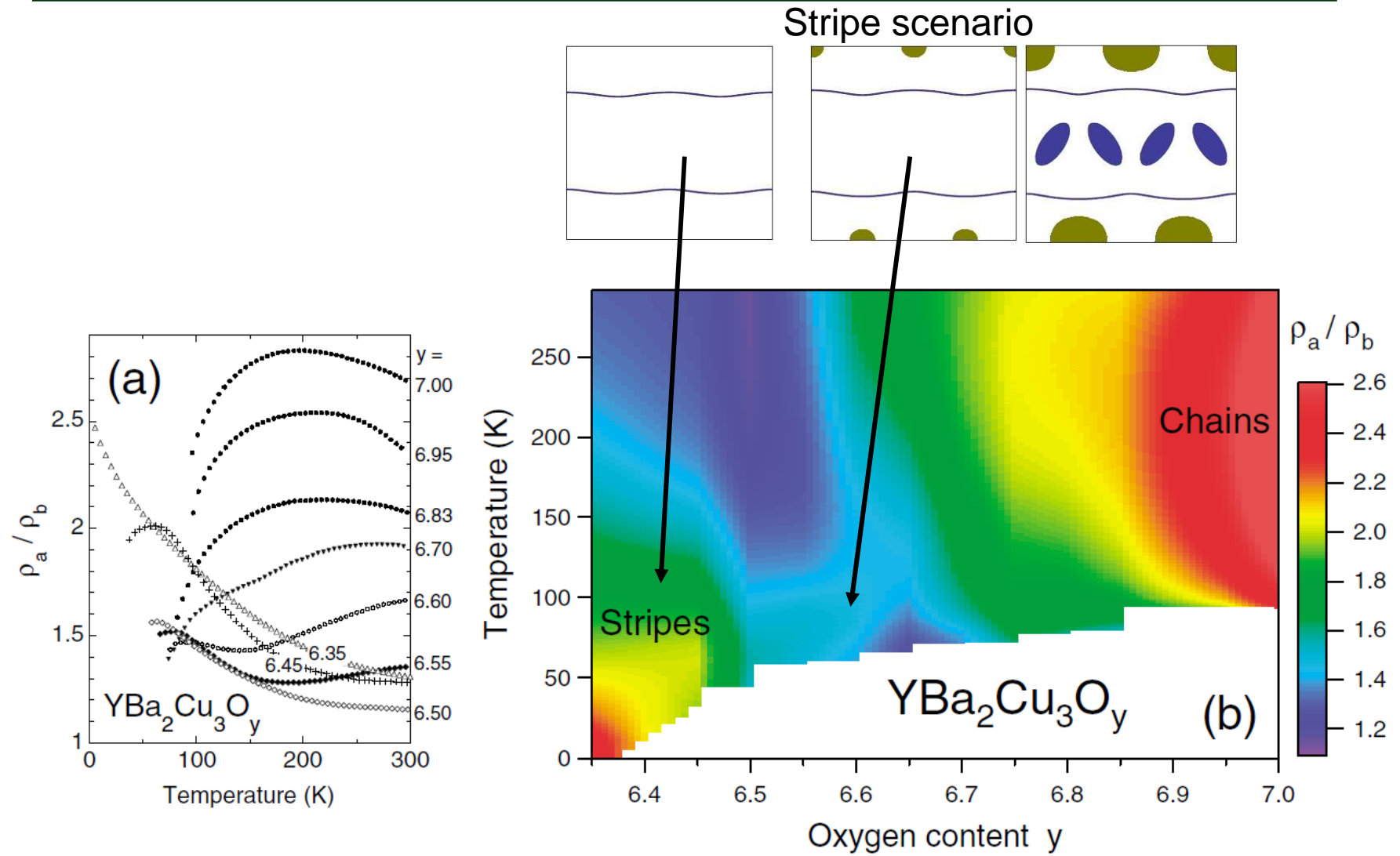

Conclusion

✓ Evidence of closed and coherent FS in UD YBCO and OD TI-2201

✓ Small pockets vs large orbit
Evidence of electron pocket



Reconstruction of the FS

✓ If pseudogap causes reconstruction \Rightarrow results in overdoped TI2201 argue for a QCP hidden by the SC dome

✓ Restoration of the coherence along c -axis at low T in underdoped YBCO

3D Fermi surface
Fermi liquid behavior

