



COLLÈGE  
DE FRANCE  
—1530—



Chaire de Physique Mésoscopique  
Michel Devoret  
Année 2012, 15 mai - 19 juin

# RÉSONATEURS NANOMÉCANIQUES DANS LE RÉGIME QUANTIQUE

## *NANOMECHANICAL RESONATORS IN QUANTUM REGIME*

Deuxième leçon / *Second lecture*

*This Collège de France document is for consultation only. Reproduction rights are reserved.*

# PROGRAM OF THIS YEAR'S LECTURES

Lecture I: Introduction to nanomechanical systems

---

Lecture II: How do we model the coupling between electromagnetic modes and mechanical motion?

---

Lecture III: Is zero-point motion of the detector variables a limitation in the measurement of the position of a mechanical oscillator?

Lecture IV: In the active cooling of a nanomechanical resonator, is measurement-based feedback inferior to autonomous feedback?

Lecture V: How close to the ground state can we bring a nanoresonator?

Lecture VI: What oscillator characteristics must we choose to convert quantum information from the microwave domain to the optical domain?

# CALENDAR OF 2012 SEMINARS

**May 15: Rob Schoelkopf (Yale University, USA)**

*Quantum optics and quantum computation with superconducting circuits.*

---

**May 22: Konrad Lehnert (JILA, Boulder, USA)**

*Micro-electromechanics: a new quantum technology.*

---

**May 29: Olivier Arcizet (Institut Néel, Grenoble)**

*A single NV defect coupled to a nanomechanical oscillator: hybrid nanomechanics.*

**June 5: Ivan Favero (MPQ, Université Paris Diderot)**

*From micro to nano-optomechanical systems: photons interacting with mechanical resonators.*

**June 12: A. Douglas Stone (Yale University, USA)**

*Lasers and anti-lasers: a mesoscopic physicist's perspective on scattering from active and passive media.*

**June 19: Tobias J. Kippenberg (EPFL, Lausanne, Suisse)**

*Cavity optomechanics: exploring the coupling of light and micro- and nanomechanical oscillators.*

# LECTURE II : INTERACTION BETWEEN LIGHT AND MOVING MIRROR IN THE QUANTUM REGIME

## OUTLINE

1. A simple hamiltonian, whose parameters span many orders of magnitude
2. Radiation pressure and the Doppler effect in a 1D deformable cavity: a fundamentally non-linear effect
3. Full coupling hamiltonian between radiation and moving mirror
4. Adiabatic approximation

# QUANTUM ELECTRO/OPTO-MECHANICS IS GOVERNED BY A SIMPLE HAMILTONIAN

$$\frac{\hat{H}}{\hbar} = \omega_e \hat{a}^\dagger \hat{a} + \omega_m \hat{b}^\dagger \hat{b} + g_3 \left( \hat{b} + \hat{b}^\dagger \right) \hat{a}^\dagger \hat{a}$$

$$\omega_m = \sqrt{\frac{K}{M}} \quad Z_m = \sqrt{KM} \quad X_{ZPF} = \sqrt{\frac{\hbar}{2Z_m}} \quad \hat{X} = X_{ZPF} (b + b^\dagger) \quad g_3 = X_{ZPF} \frac{\omega_e}{\ell_0}$$

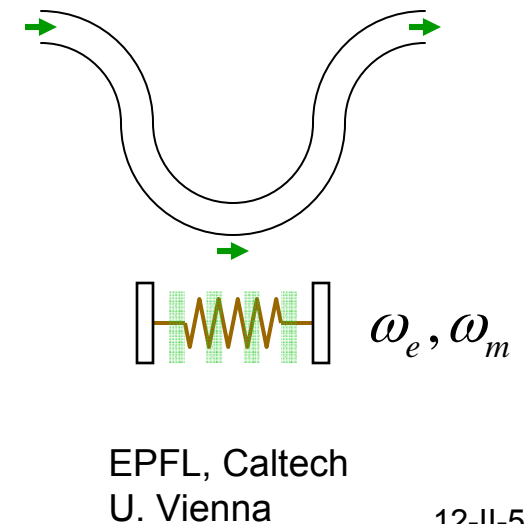
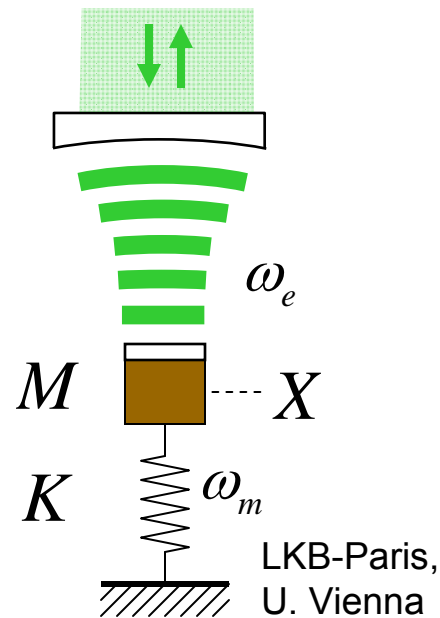
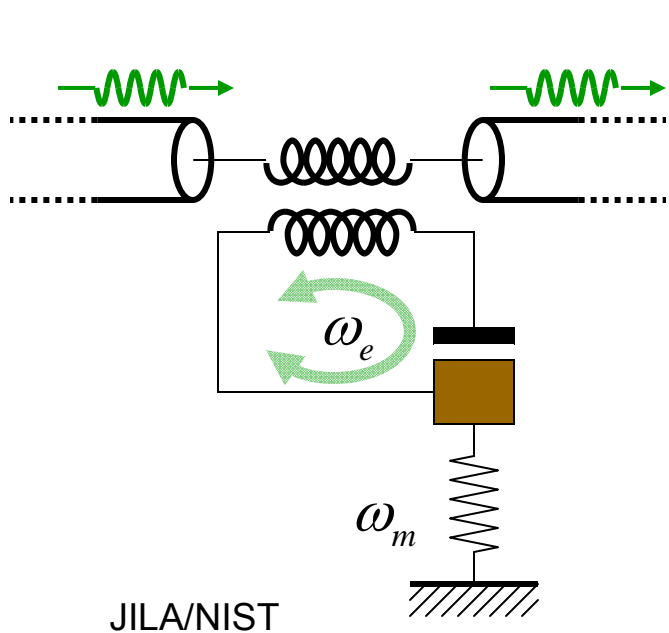

# QUANTUM ELECTROMECHANICS

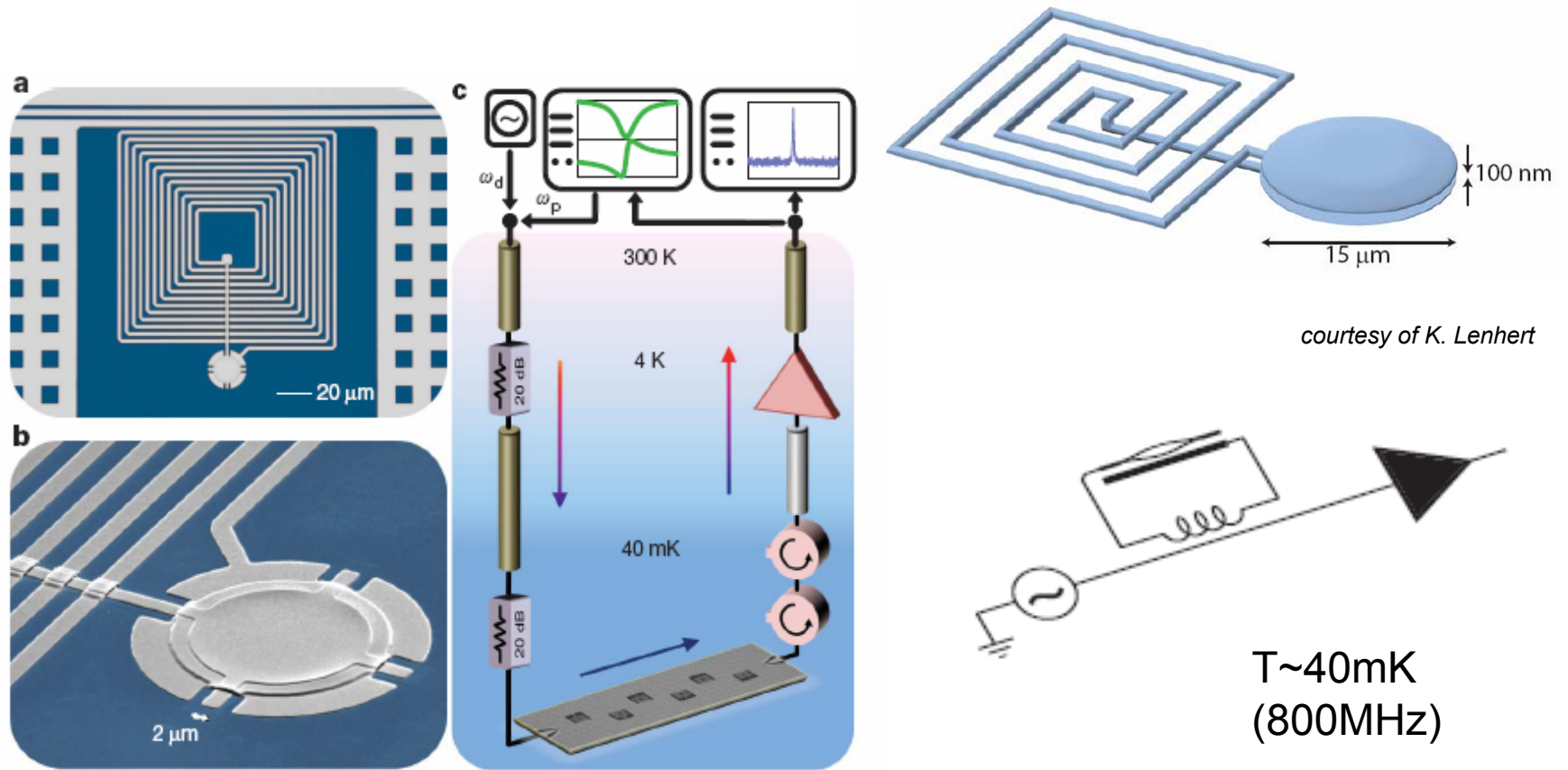

Teufel *et al.*, Nature 471, 208 (2011)

JILA/NIST

# QUANTUM OPTOMECHANICS (1)

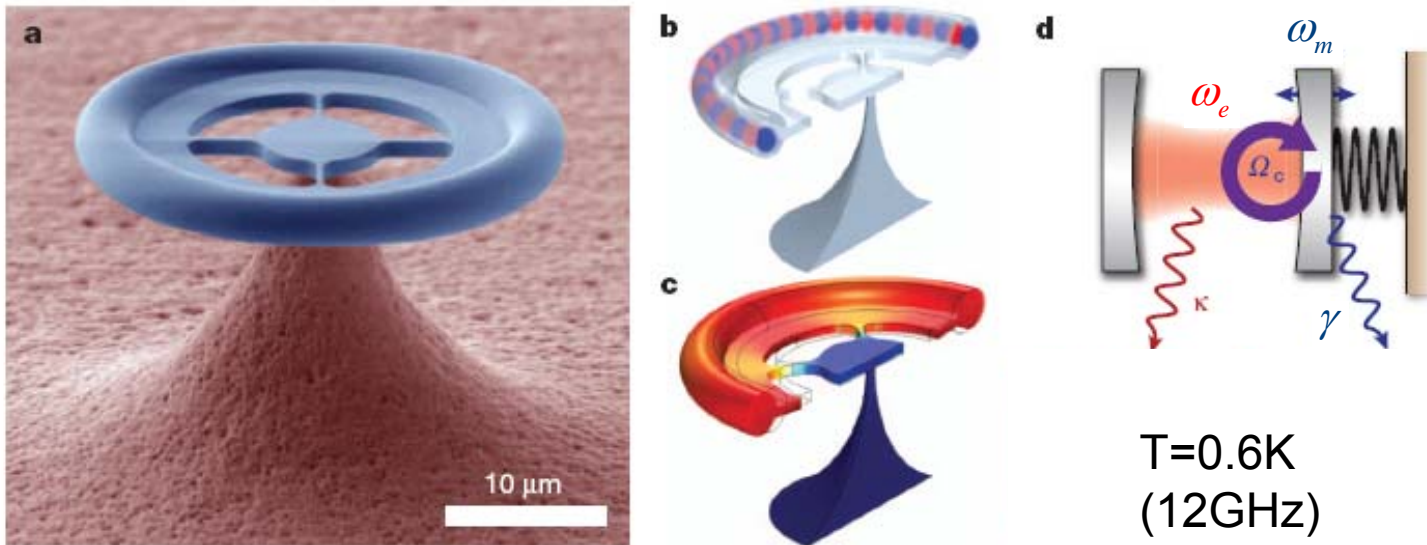

Verhagen, Deeglise, Weis, Schliesser and Kippenberg, Nature 482, 66 (2012)

EPFL

# QUANTUM OPTOMECHANICS(2)

T~20K  
(400GHz)

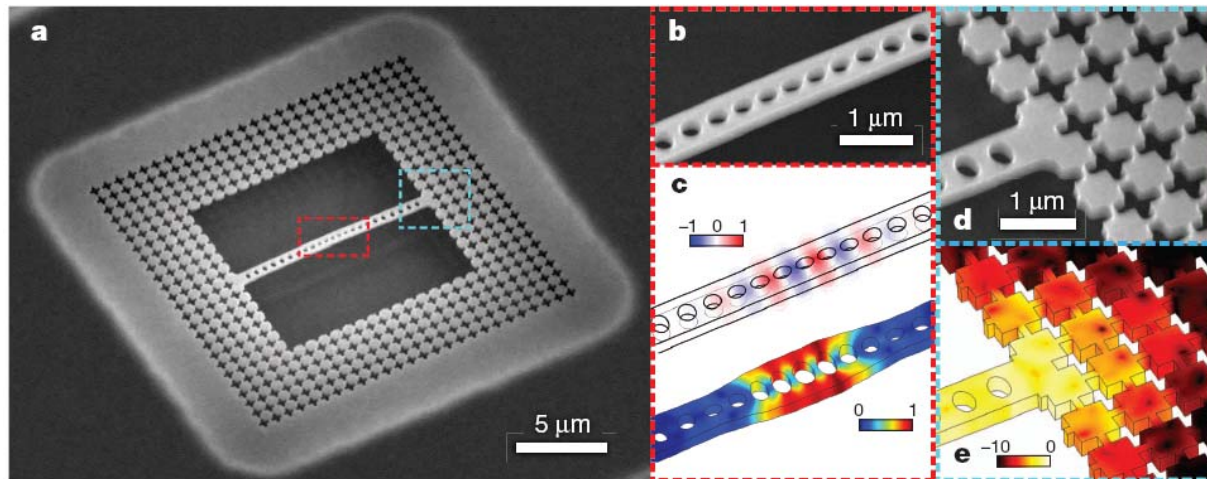

*Chan et al., Nature 478, 90 (2011)*

CALTECH, U. VIENNA



# ORDERS OF MAGNITUDE

Group	$\omega_m$	$Q_m$ $=\omega_m/\gamma$	$X_{ZPF}$	$\omega_e$	$Q_e$ $=\omega_e/\kappa$	$g_3$	$\omega_m/\kappa$
JILA/NIST K. Lehnert, R. Simmonds	10.56 MHz	$3.3 \times 10^5$	4.1fm	7.54 GHz	$4 \times 10^4$	0.5 kHz	50
EPFL T. Kippenberg	78 MHz	34	~1fm	385 THz	$5 \times 10^7$	3.4 kHz	11
Caltech/Vienna O. Painter, M. Aspelmeyer	3.68 GHz	$10^5$	3fm	195 THz	$5 \times 10^5$	500 kHz	7

HOW IS THE HAMILTONIAN ABOVE, ALLOWING TO MEASURE fm  
DISPLACEMENTS, CONNECTED TO THE ONE RESPONSIBLE FOR THE  
DOPPLER MEASUREMENT OF VELOCITY AND THE ATTRACTION  
BETWEEN TWO PLATES SUBMITTED TO AN AC VOLTAGE?

WHAT APPROXIMATIONS ARE MADE IN THIS SIMPLE HAMILTONIAN?

THE CONNECTION BETWEEN RADIATION PRESSURE AND  
THE DOPPLER EFFECT CAN BE EXPLORED USING A  
SIMPLE MODEL, WHICH WILL ANSWER THESE QUESTIONS.

Reference: C. K. Law, Phys. Rev. **A 51**, 2537 (1995)

# AN ELEMENTARY, DEFORMABLE 1D RESONATOR

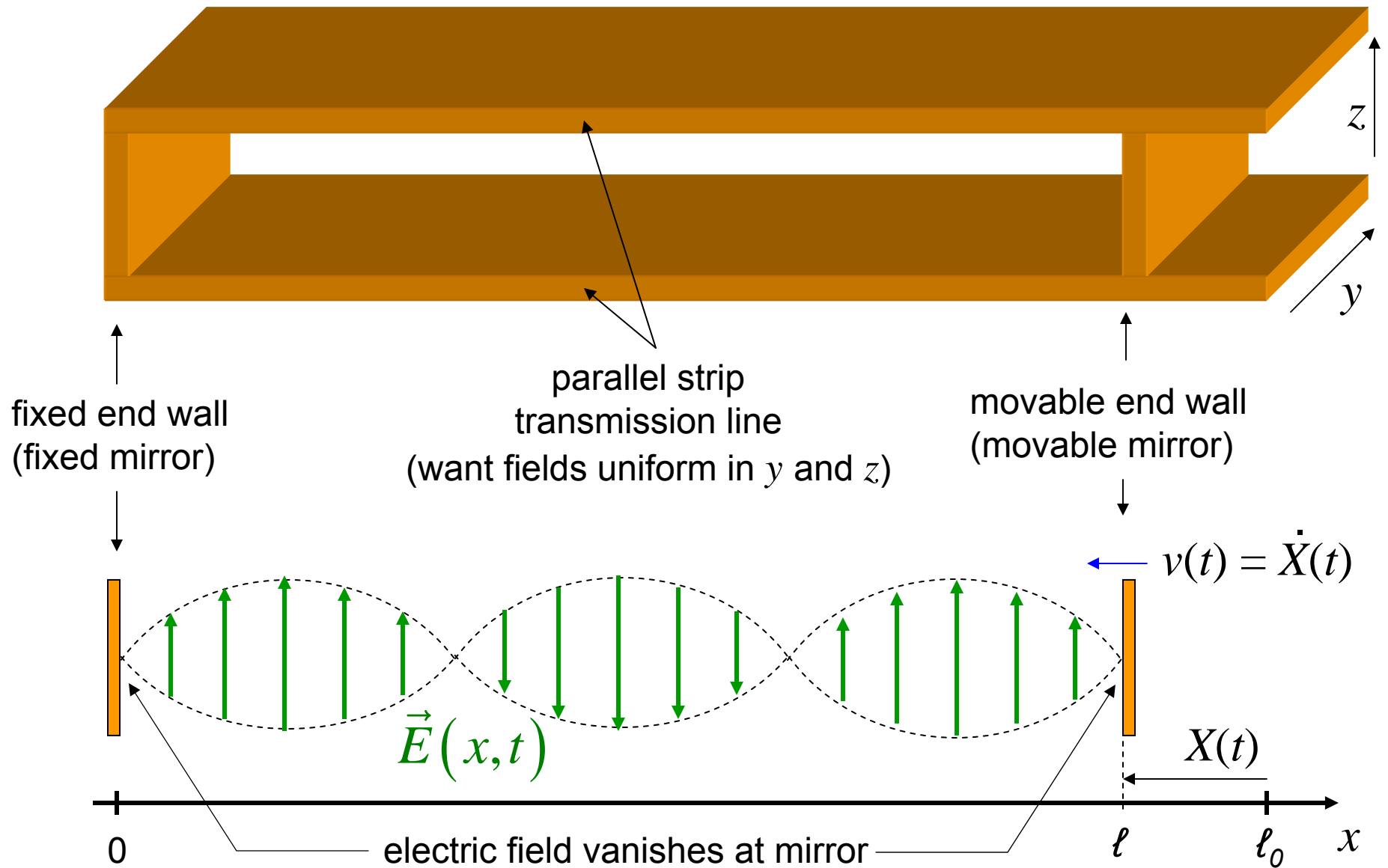

# A SIMPLE, DEFORMABLE 1D RESONATOR (CNT'D)

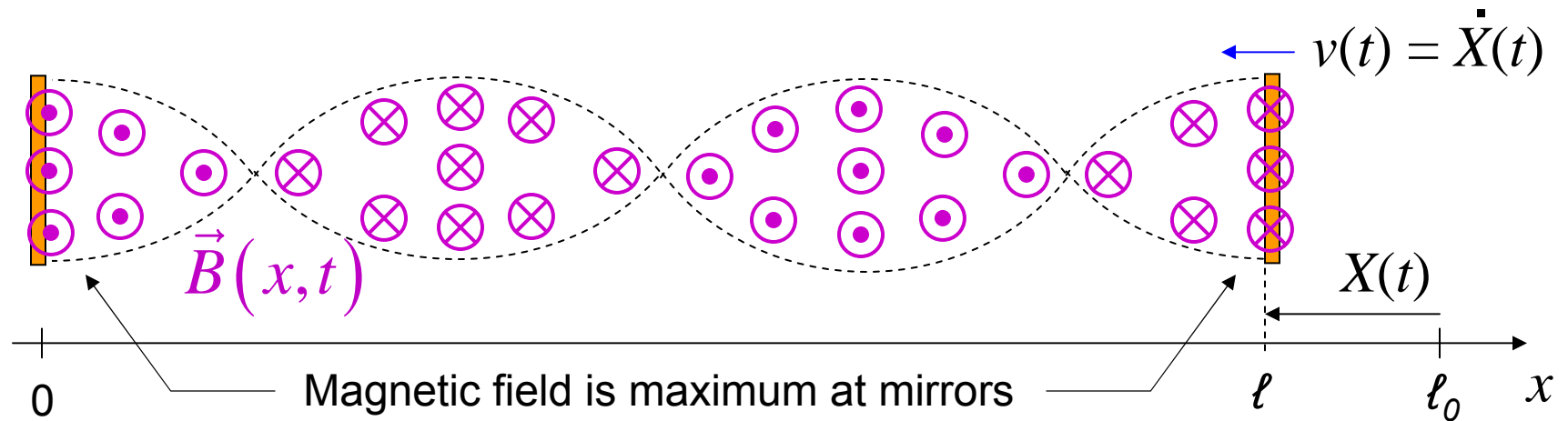

Treat vector potential in radiation gauge (a.k.a. Coulomb or transverse gauge)

$$\vec{A}(x,t) = A(x,t) \hat{z}$$

The mirrors are perfectly conducting and inside the cavity, no sources are present.  
Thus:

$$A(l(t),t) = A(0,t) = 0 \quad \vec{E}(x,t) = -\frac{\partial A(x,t)}{\partial t} \hat{z} \quad \vec{B}(x,t) = -\frac{\partial A(x,t)}{\partial x} \hat{y}$$

The vector potential obeys:

$$\left[ \frac{\partial^2}{\partial x^2} - \frac{1}{c^2} \frac{\partial^2}{\partial t^2} \right] A(x,t) = 0 \quad \text{speed of light}$$

# ENERGY INSIDE RESONATOR

Instantaneous energy density inside resonator:

$$\begin{aligned}\mathcal{E}(x,t) &= \frac{\epsilon_0}{2} \vec{E}(x,t)^2 + \frac{1}{2\mu_0} \vec{B}(x,t)^2 \\ &= \frac{\epsilon_0}{2} \left[ \frac{\partial}{\partial t} A(x,t) \right]^2 + \frac{1}{2\mu_0} \left[ \frac{\partial}{\partial x} A(x,t) \right]^2\end{aligned}$$

Instantaneous total energy inside resonator:

$$\mathcal{U} = \underset{\substack{\uparrow \\ \text{mirror area}}}{S} \int_0^{\ell} \mathcal{E}(x,t) dx = S \int_0^{\ell} \left\{ \frac{\epsilon_0}{2} \left[ \frac{\partial}{\partial t} A(x,t) \right]^2 + \frac{1}{2\mu_0} \left[ \frac{\partial}{\partial x} A(x,t) \right]^2 \right\} dx$$

Crucial details are that  $\ell$  is an implicit function of time through the dynamics of  $X$   
and that at all times  $A(\ell(t), t) = A(0, t) = 0$



# PHOTON APPROACH TO RADIATION PRESSURE

Photons each  
have energy  $E$   
momentum  $E/c$

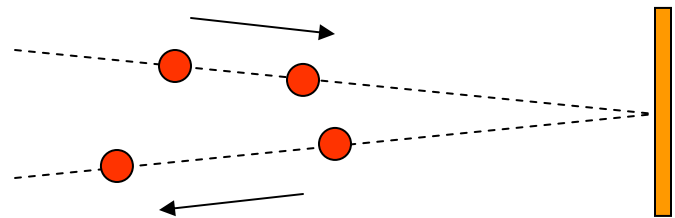

Photons bounce on mirror

Momentum transfer to mirror:  $2E/c$  per photon  
(when perfect back-scattering)

Pressure: momentum transfer per unit area per unit time

Radiation pressure:  $2 \times$  incoming energy flux /  $c$

$$p = 2 \frac{|\vec{S}_{in}|}{c} = 2 \frac{|\vec{E}_{in} \times \vec{B}_{in}|}{\mu_0 c}$$

Poynting vector

TEM mode in cavity

$$= 2 \frac{|\vec{B}_{in}|^2}{\mu_0} = \frac{|\vec{B}_{mirror}|^2}{2\mu_0}$$

Confirms wave approach!

# NORMAL MODES OF A CAVITY WHOSE SHAPE DEPENDS ON TIME

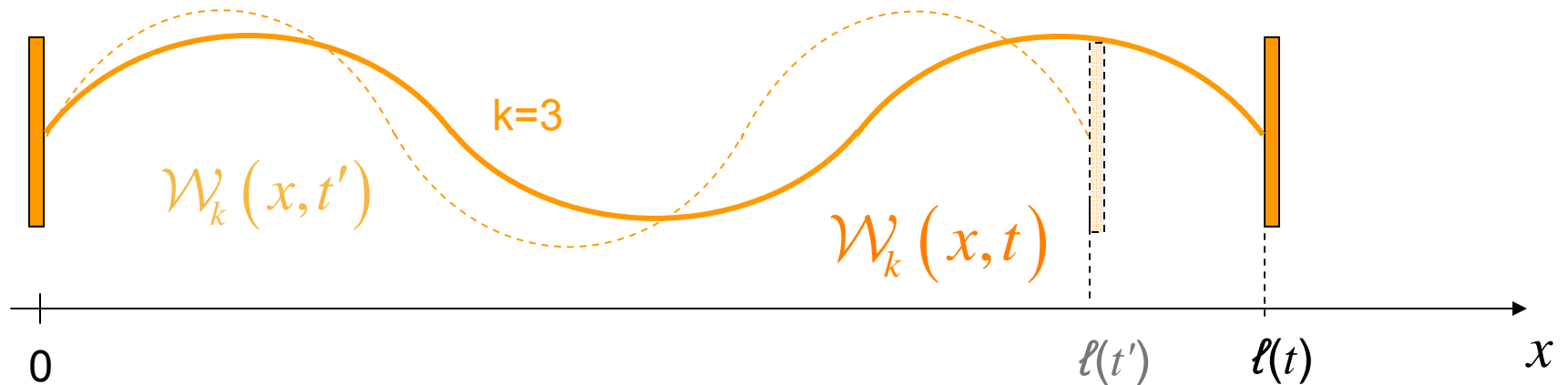

$$W_k(x, t) = \sqrt{\frac{2}{l(t)}} \sin \frac{\pi k x}{l(t)}$$

Both wavelength and amplitude are time dependent.  
Symbol  $k$  : integer.

$$\int_0^{l(t)} W_k(x, t) W_{k'}(x, t) dx = \delta_{k, k'}$$

Orthonormality condition is independent of time.  
(scheme is not relativistic, OK here)

Mode frequency:

$$\omega_k[l(t)] = \frac{\pi c k}{l(t)}$$

Also varies with time!



# GENERALIZED NORMAL COORDINATES OF FIELD INSIDE CAVITY

Normal coordinates

$$q_k(t) = \int_0^{\ell(t)} A(x,t) \mathcal{W}_k(x,t) dx$$

Countable infinity of degrees of freedom.

In turn, the field can be expressed in terms of normal coordinates:

$$A(x,t) = \sum_{k=1}^{\infty} q_k(t) \mathcal{W}_k(x,t)$$

Completeness  
of mode functions

Dimensional analysis:

$$[q] = [\Phi] \cdot [\ell]^{1/2}$$

↑  
flux

# CLASSICAL EQUATIONS OF MOTION FOR FIELD NORMAL COORDINATES AND MIRROR POSITION

Field equation:  $c^2 \frac{\partial^2}{\partial x^2} A(x,t) = \frac{\partial^2}{\partial t^2} A(x,t)$

$$\omega_k^2 q_k = -\ddot{q}_k + \frac{2\dot{\ell}}{\ell} \sum_j g_{kj} \dot{q}_j - \frac{\dot{\ell}^2 - \ddot{\ell}\ell}{\ell^2} \sum_j g_{kj} q_j + \frac{\dot{\ell}^2}{\ell^2} \sum_{j,l} g_{jk} g_{jl} q_l$$

Newton's Law for mirror:

$$M \ddot{\ell} = -\frac{\partial V(\ell)}{\partial \ell} + \frac{1}{\mu_0 c^2 \ell} \sum_{k,j} (-1)^{k+j} \omega_k \omega_j q_k q_j$$

↑  
mech<sup>al</sup>  
force
radiation pressure force

coupled equations:

light presses on mirror,  
mirror pumps energy  
into or out of light.

where:  $\omega_k(\ell) = \frac{\pi c k}{\ell}$       and:  $g_{kj} = \begin{cases} (-1)^{k+j} \frac{2kj}{j^2 - k^2}, & k \neq j \\ 0, & k = j \end{cases}$

# DOPPLER EFFECT

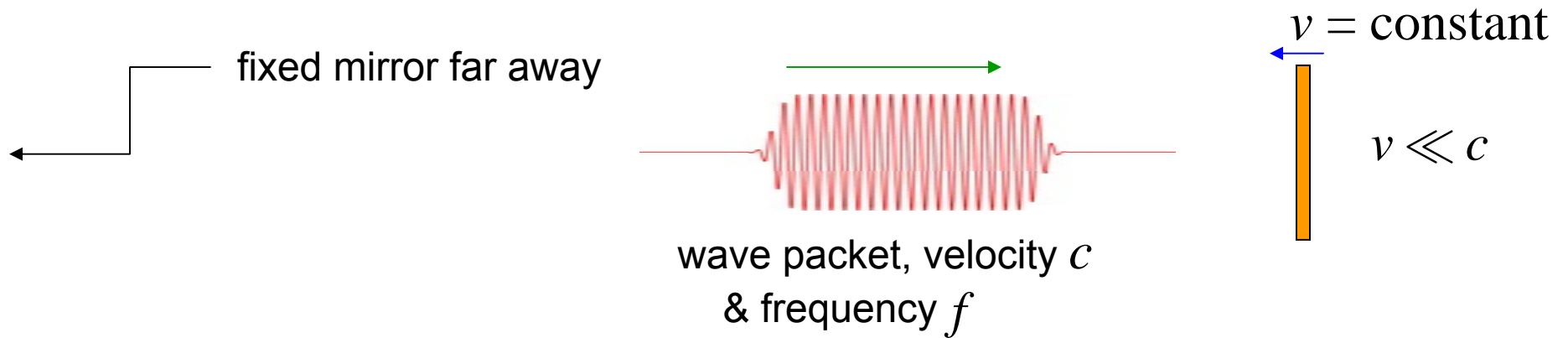

After reflection:

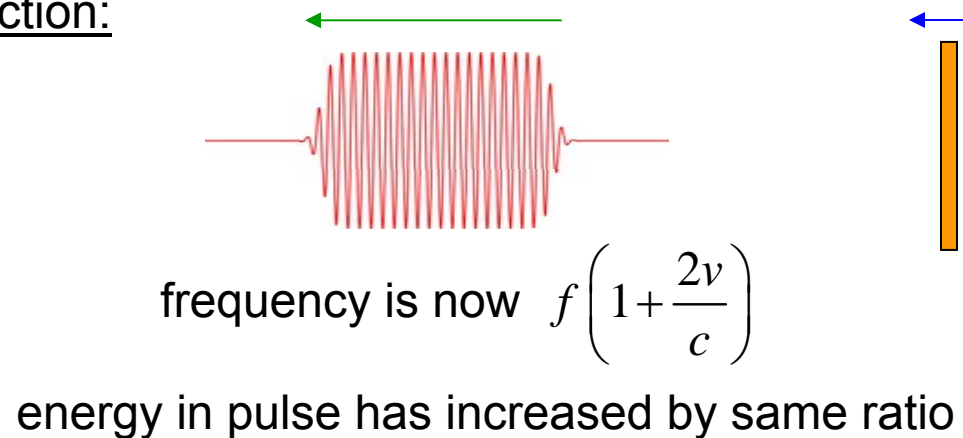

# DOPPLER EFFECT FROM PHOTON POINT OF VIEW

Process is so far completely classical but can be interpreted in particle language:

before collision with mirror

$$P = mV$$

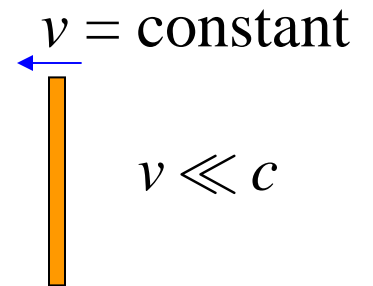
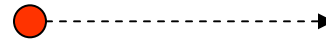

after collision with mirror

$$P' = mV \left( 1 + \frac{2v}{V} \right)$$

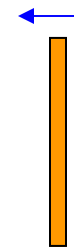
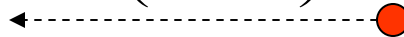

Particle bouncing elastically on a moving heavy wall sees its momentum  $P$  increased by  $2mv$ , where  $m$  is particle mass and  $v$  the wall velocity. Relative increase in  $P$  is thus  $(1 + 2v/V)$ , where  $V$  is the velocity of the particle. We can apply this idea to the photon:

$$P = \frac{\hbar\omega}{c} \rightarrow P' = \frac{\hbar\omega}{c} \left( 1 + \frac{2v}{c} \right)$$

# FULL HAMILTONIAN OF CAVITY WITH MOVING MIRROR IN THE NON-RELATIVISTIC APPROXIMATION

From the classical equations, it is possible to construct a Lagrangian. One obtains the conjugate momenta and the quantum Hamiltonian by imposing standard commutation relation between coordinates and momenta.

$$\hat{H} = \frac{(\hat{p} + \hat{\Pi})^2}{2M} + V(\hat{\ell}) + \hbar \sum_{k=1}^{\infty} \omega_k(\hat{\ell}) \hat{a}_k^\dagger \hat{a}_k - \frac{\pi \hbar c}{\hat{\ell}}$$

where

$$\hat{\Pi} = \frac{i\hbar}{2\hat{\ell}} \sum_{k,j} \left[ g_{kj} \left( \frac{k}{j} \right)^{1/2} \left( \hat{a}_k^\dagger \hat{a}_j^\dagger - \hat{a}_k \hat{a}_j + \hat{a}_k^\dagger \hat{a}_j - \hat{a}_j^\dagger \hat{a}_k \right) \right]$$

and

$$\left[ \hat{a}_j(\hat{\ell}), \hat{a}_k^\dagger(\hat{\ell}) \right] = \delta_{jk}$$

Casimir  
interaction  
(1-D)

Hamiltonian contains Doppler shift, radiation pressure and Casimir effect. First term resembles usual gauge coupling of charged particle. But here, mirror is neutral.

Motion is non-relativistic and bounded by condition :  $\ell > 0$ .

# TWO APPROXIMATIONS

If  $\hat{X} = \hat{\ell} - \ell_0 \ll \ell_0$  Very well obeyed for nanoresonators in quantum regime!  
(small displacement condition)

Then, after a gauge transformation:  $\hat{H}_1 = \hat{T}^\dagger \hat{H} \hat{T}; \quad \hat{T} = \exp(i\hat{\Pi}\hat{X})$

$$\hat{H}_1 \cong \frac{\hat{P}^2}{2M} + U(\hat{X}) + \hbar \sum_{k=1}^{\infty} \omega_{k0} \hat{a}_{k0}^\dagger \hat{a}_{k0} - \hat{X} \hat{F}_0$$

includes Casimir force  
radiation pressure

$$\hat{F}_0 = \frac{\hbar}{2\ell_0} \sum_{k,j} (-1)^{k+j} \sqrt{\omega_{k0} \omega_{j0}} \left( \hat{a}_{k0} \hat{a}_{j0} + \hat{a}_{k0}^\dagger \hat{a}_{j0}^\dagger + \hat{a}_{k0}^\dagger \hat{a}_{j0} + \hat{a}_{j0}^\dagger \hat{a}_{k0} \right)$$

Harmonic restoring force for mirror:  $U(\hat{X}) = \frac{K\hat{X}^2}{2}$

If  $\omega_m = \sqrt{\frac{K}{M}} \ll |\omega_{k0} - \omega_{j0}|, \forall (k, j)$  Adiabatic condition

For a strictly 1D resonator, it corresponds to period of mirror motion much slower than roundtrip of photon.

we finally arrive at:  $\hat{H}_1 \cong \frac{\hat{P}^2}{2M} + \frac{K\hat{X}^2}{2} + \hbar\omega_e \left( 1 + \frac{\hat{X}}{\ell_0} \hat{a}^\dagger \hat{a} \right)$  QED!

# ELECTROSTATIC PRESSURE

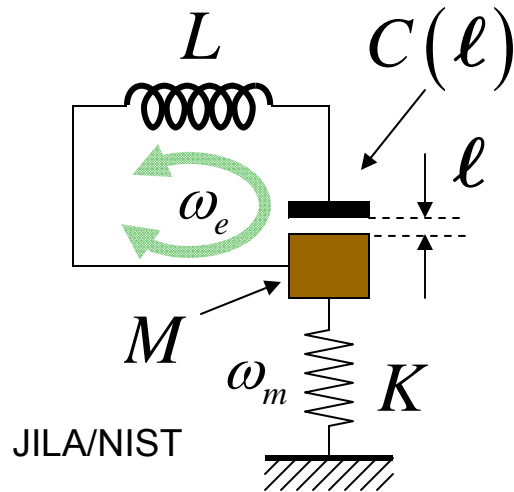

$$X = l - l_0 \ll l_0$$

$$C = \varepsilon \frac{S}{l} \cong \varepsilon \frac{S}{l_0} \left( 1 - \frac{X}{l_0} \right)$$

$$\hat{H} = \frac{\hat{\Phi}^2}{2L} + \frac{\hat{Q}^2}{2C_0} \left( 1 - \frac{\hat{X}}{l_0} \right) + \frac{\hat{P}^2}{2M} + \frac{K\hat{X}^2}{2}$$

$$\hat{Q} = Q_{ZPF} (a + a^\dagger); \quad \hat{X} = X_{ZPF} (b + b^\dagger)$$

$$\omega_e = \frac{1}{\sqrt{LC_0}}; \quad Z_e = \sqrt{\frac{L}{C_0}}$$

$$Q_{ZPF} = \sqrt{\frac{\hbar}{2Z_e}}$$

$$\frac{\hat{H}}{\hbar} = \frac{\omega_e}{4} \left[ -(a - a^\dagger)^2 + (a + a^\dagger)^2 \left( 1 - \frac{X_{ZPF}}{l_0} (b + b^\dagger) \right) \right] + \omega_m b^\dagger b$$

Since  $\omega_e \gg \omega_m$   
can neglect terms  
in  $a^{\dagger 2}, a^2$

$$\frac{\hat{H}}{\hbar} \cong \omega_e a^\dagger a \left( 1 - \frac{X_{ZPF}}{2l_0} (b + b^\dagger) \right) + \omega_m b^\dagger b$$

# 4-WAVE NON-LINEARITY

Sankey, Yang, Zwickl, Jayich, and Harris, Nature Physics **6**, 707 (2010)

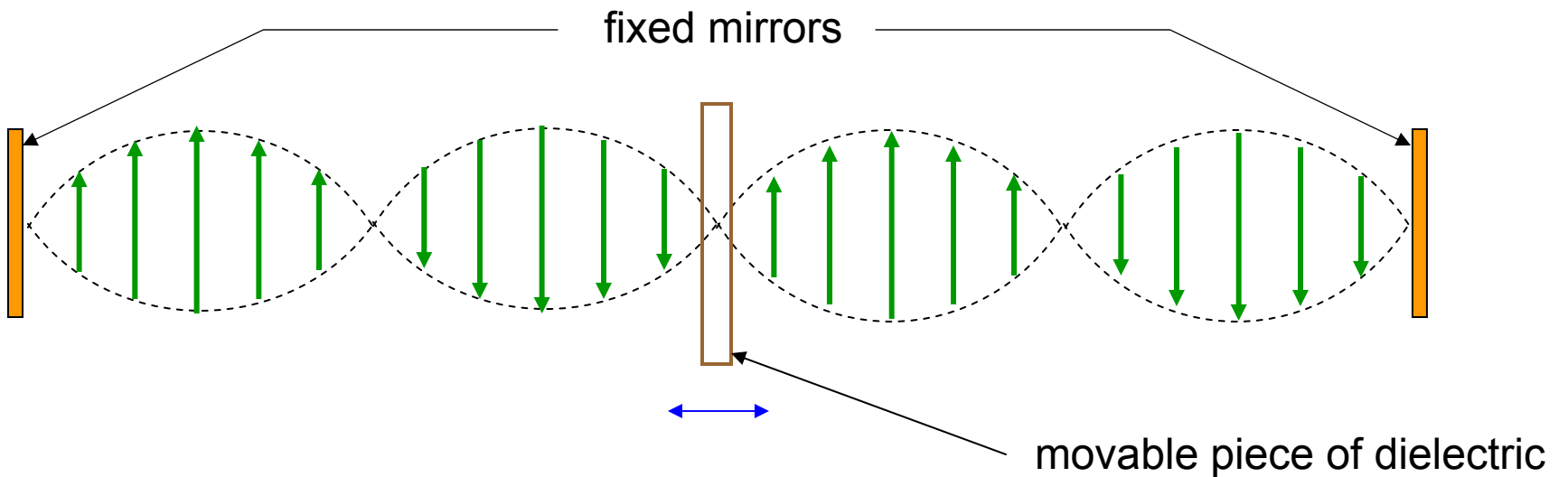

Symmetry excludes from coupling hamiltonian terms odd in mechanical position

$$\frac{\hat{H}}{\hbar} = \omega_e \hat{a}^\dagger \hat{a} + \omega_m \hat{b}^\dagger \hat{b} + g_4 \left( \hat{b} + \hat{b}^\dagger \right)^2 \hat{a}^\dagger \hat{a}$$

Can be used to read phonon number directly.

$$g_4 = \left( X_{ZPF} \right)^2 \frac{\partial^2 \omega_e}{\partial \ell^2}$$



# SELECTED BIBLIOGRAPHY FOR THE COURSE

## Books

- Braginsky, V. B., and F. Y. Khalili, "Quantum Measurements" (Cambridge University Press, Cambridge, 1992).
- Clarke, J. and Braginsky, A. I., eds., "The SQUID Handbook" (Wiley-VCH, Weinheim, Germany, 2006).
- Cleland, A. N., "Foundations of Nanomechanics", (Springer, Berlin, 2010)
- Cohen-Tannoudji, C., Dupont-Roc, J., Grynberg, G., "Photons and Atoms", (Wiley, New York, 1989)
- Gardiner, C.W. and Zoller, P. "Quantum Noise" (Springer, Berlin, 2004).
- Haroche, S. and Raimond, J-M., "Exploring the Quantum" (Oxford University Press, 2006).
- Pozar, D. M., "Microwave Engineering" 3rd edn (Wiley, New York, 2004 )
- Walls, D.F., and Milburn, G.J. "Quantum Optics" (Springer, Berlin, 2008)
- Wiseman, H.M. and Milburn, G.J., "Quantum Measurement and Control" (Cambridge, 2011)

## Articles

- O. Arcizet, P. F. Cohadon, T. Briant, M. Pinard, A. Heidmann, Nature **444**, 71 (2006)
- Chan J., *et al.*, "Laser cooling of a nanomechanical oscillator into its quantum ground state", Nature **478**, 89 (2011)
- P. F. Cohadon, A. Heidmann, M. Pinard, Phys. Rev. Lett. **83**, 3174 (1999)
- O'Connell A. D. *et al.*, "Quantum ground state and single-phonon control of a mechanical resonator", Nature **464**, 697 (2010)
- Clerk A. A., Devoret M. H., Girvin S. M., Marquardt F., and Schoelkopf R. J., "Introduction to Quantum Noise, Measurement and Amplification", Rev. Mod. Phys. **82**, 1155 (2010)
- Devoret M. H., and Schoelkopf R.J., Nature **406**, 1039-1046 (2000)
- Favero, I., and Karrai, K., "Optomechanics of deformable optical cavities", Nature Photonics **3**, 201 (2009)
- Marquardt F., Chen J. P., Clerk A. A. and Girvin S. M., "Quantum theory of cavity-assisted sideband cooling of mechanical motion", Phys. Rev. Lett. **99**, 093902 (2007)
- Kippenberg, T. J. and Vahala, K. J., "Cavity optomechanics: back-action at the mesoscale", Science **321**, 1172–6 (2008)
- Safavi-Naeini A. H., *et al.*, "Observation of Quantum Motion of a Nanomechanical Resonator", Phys. Rev. Lett. **108**, 033602 (2012)
- Teufel J.D. *et al.*, "Sideband cooling of micromechanical motion to the quantum ground state", Nature **475**, 359 (2011)

END OF LECTURE