

SYK: from quantum ergodicity to quantum gravity

Julian Sonner



Collège de France
Paris 3 June 2022

Introduction

Quantum mechanical unitarity and gravitational physics have long had a fraught relationship. Examples:

- Black hole information problem (e.g. the Page curve)
- Long-time behaviour of observables (e.g. 2-pt functions)

Such paradoxes arise when attempting to interpret black holes as thermodynamic entities [Bekenstein, Hawking,...]

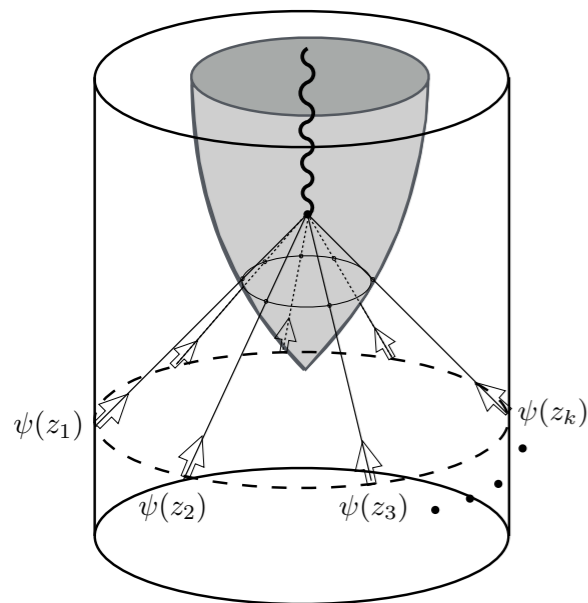

Strategy: study quantum thermalisation at all relevant timescales (e.g. AdS/CFT)

➔ **Thermalisation**, quantum chaos, quantum ergodicity

[Anous, Hartman, Rovai, JS] [Eberlein, Kasper, Sachdev, Steinberg], [...]

Chaos and gravity

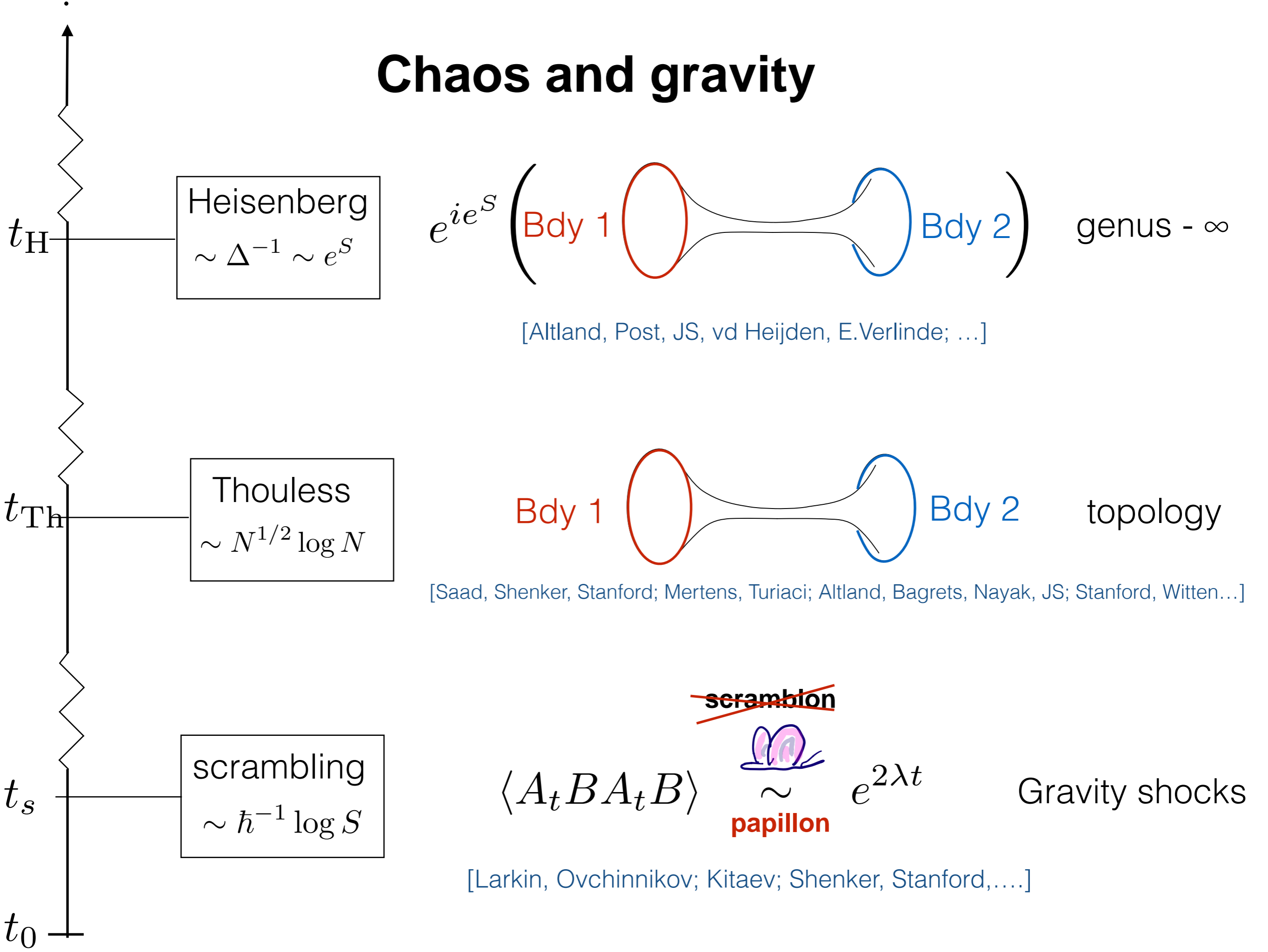

Spectral Quantum Chaos

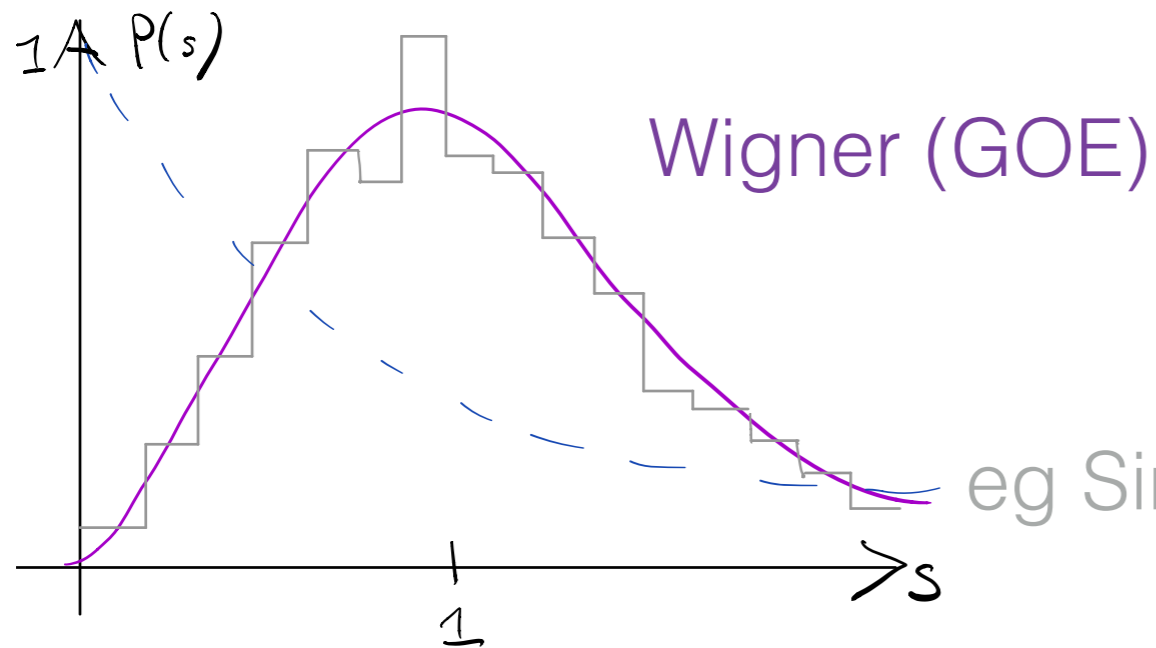

Energy levels follow RMT law

(on scale of a few $\Delta = e^{-s}$)

eg Sinai Billiards

(Doubly) non-perturbative spectroscopy

Related quantity:
spectral form factor

(= Fourier transform of two-level correlation $R_2(\omega)$)

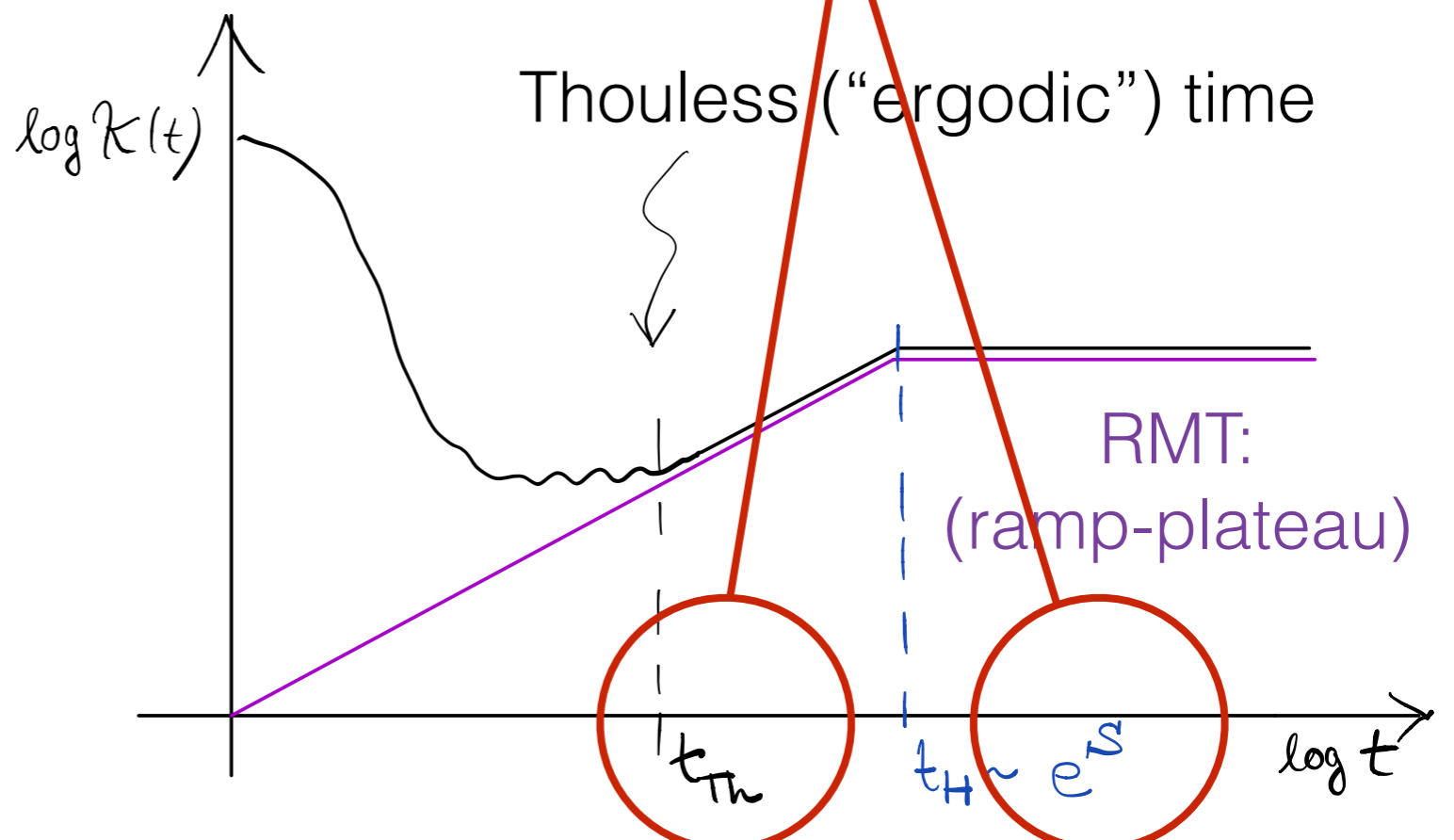

Semiclassical gravity

We can calculate semiclassically (including 1-loop dets):

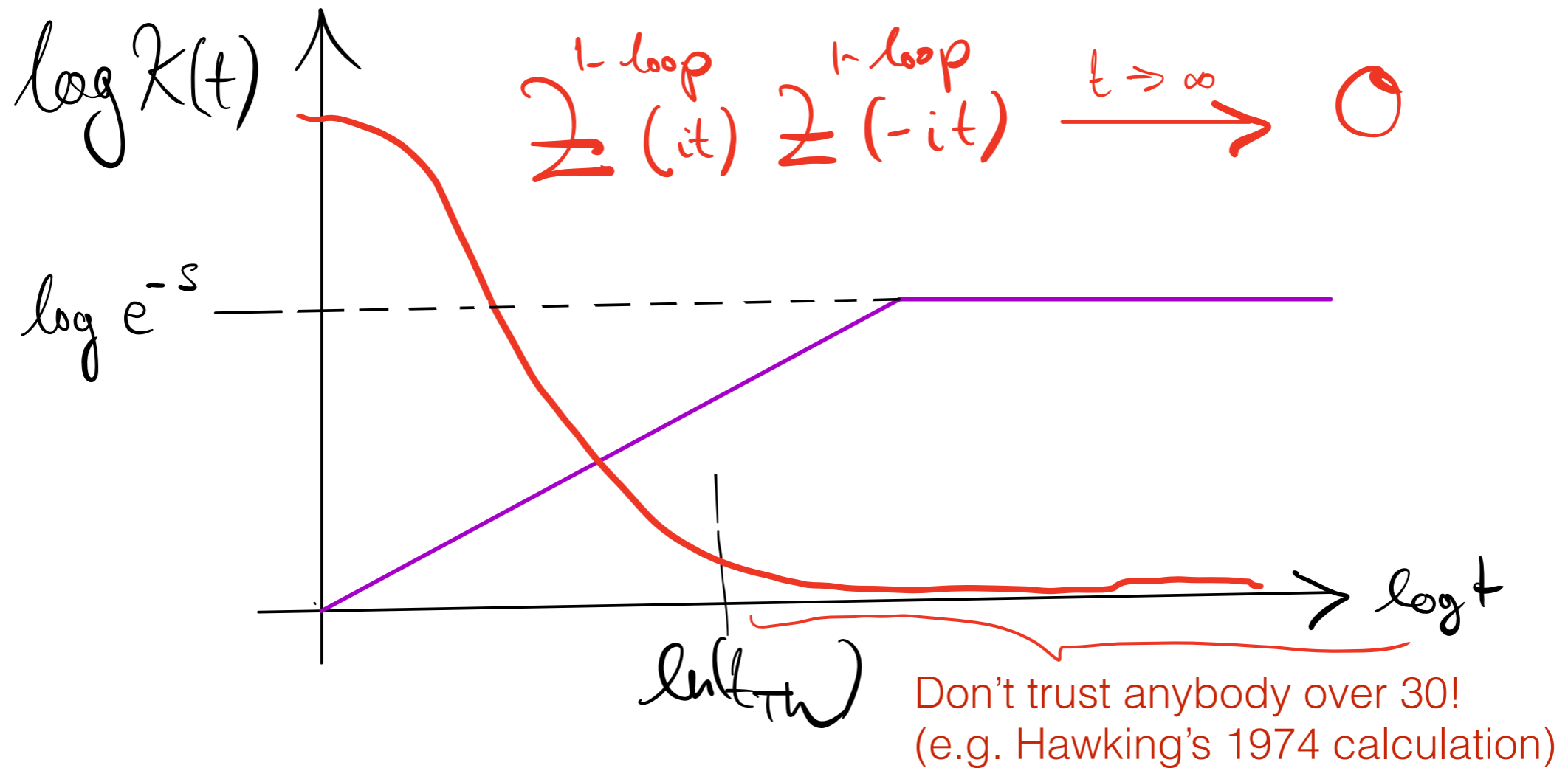

Late-time behaviour at odds with basic unitarity!

Enter SYK

random (quenched) disorder model with all-to-all couplings

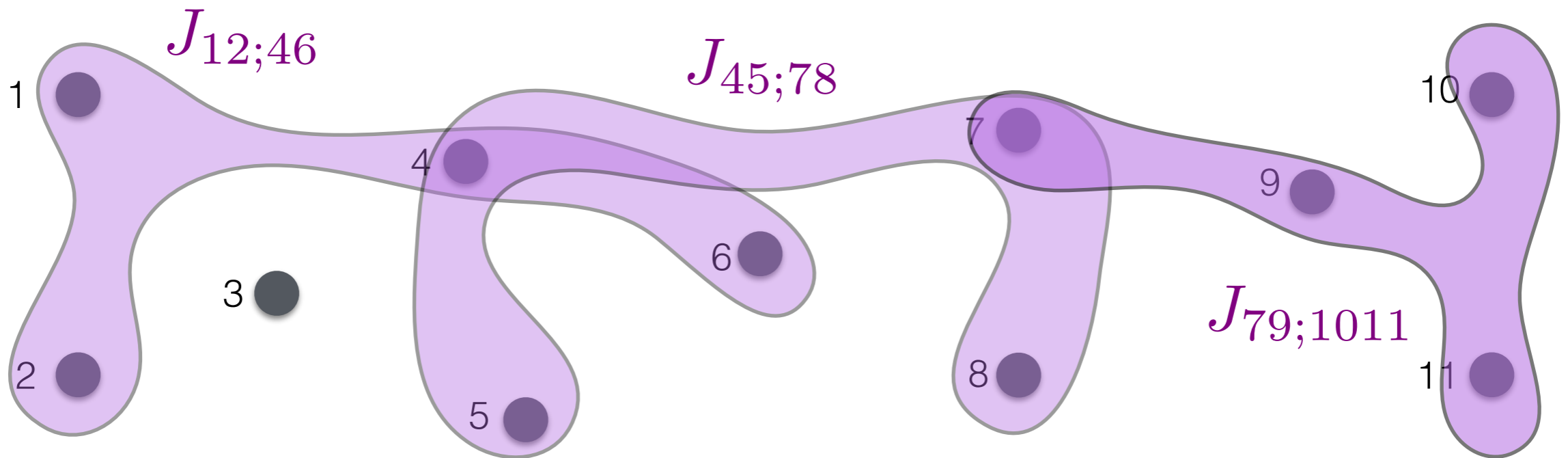

$$H = \sum_{1 \leq i < j < k < l \leq N} J_{ijkl} \psi_i \psi_j \psi_k \psi_l$$

Couplings J_{ijkl} are drawn from a Gaussian random distribution with zero mean and $\overline{J_{ijkl}^2} = J^2 / N^3$

[Sachdev, Ye; Parcollet, Georges, Kitaev.]

Model is dual to a bulk theory that includes a gravity sector ('the Schwarzian')

SYK lessons for gravity

At band edge: $\rho(E) = e^{s_0} \sinh(2\pi\sqrt{E})$ “Schwarzian density”

This coincides with that of 2D “JT gravity” → extends to full holographic duality

SYK satisfies ETH for one realisation (as well as ensemble averaged)

“One for all, all for one”

[JS, Nayak, Vielma] [Haque et al.]

SYK spectral form-factor known numerically & analytically

[Cotler et al.;
Altland, Bagrets, JS, et al.]

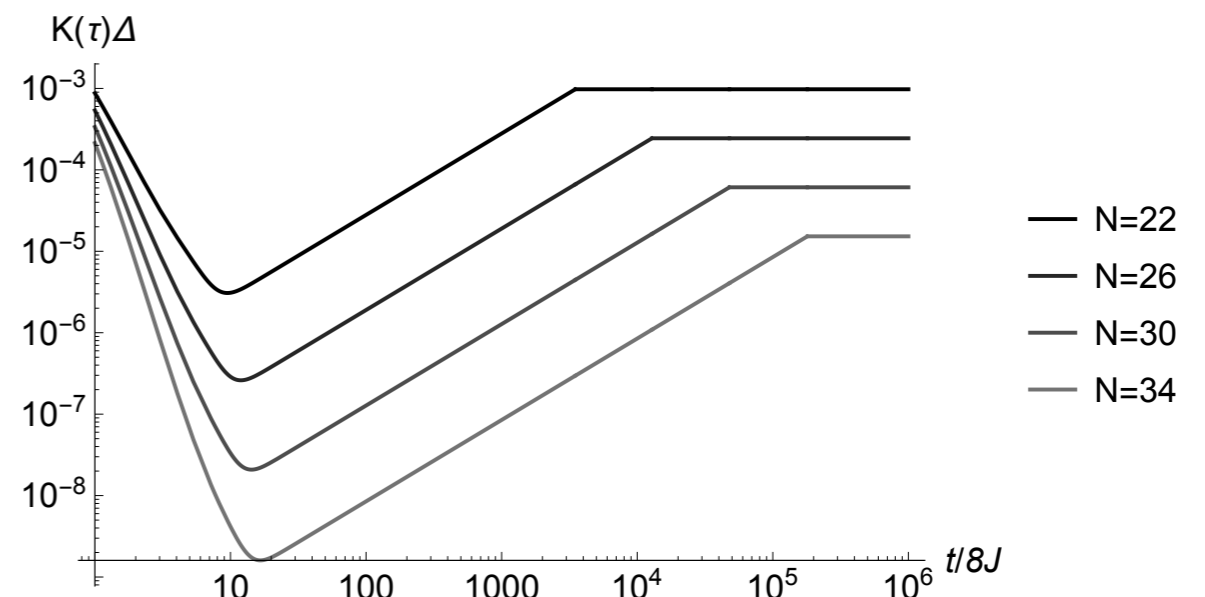
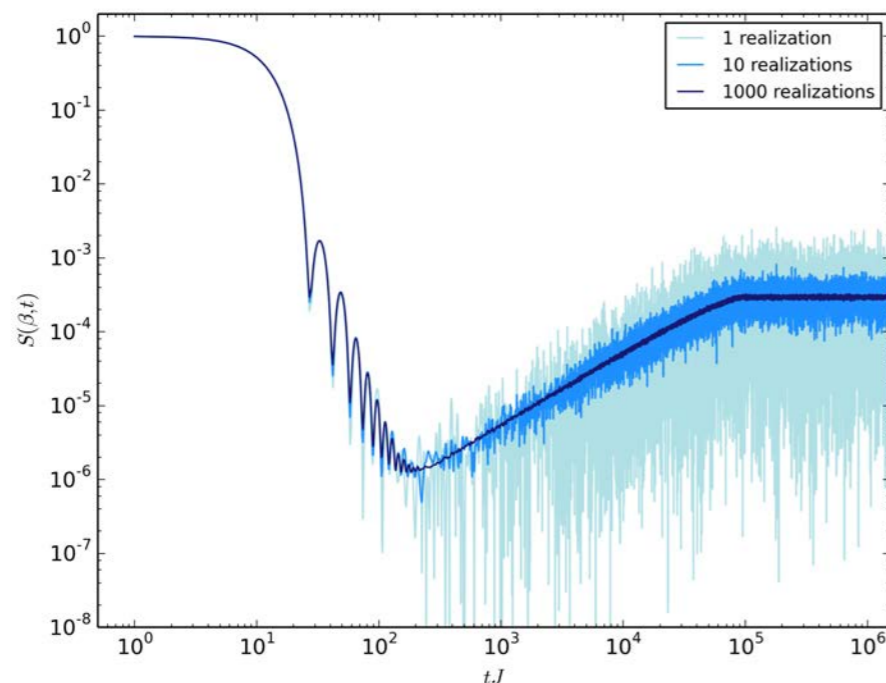

(2d) gravity & topology

Can we find the gravity description of this behaviour?

$$S_{\text{JT}}[g, \phi] = -S_0 \chi(M) - \frac{1}{2} \int_M d^2x \sqrt{g} \phi (\mathcal{R} + 2) \quad (2\text{D JT gravity})$$

This has a topological expansion [Saad, Shenker, Stanford; Mirzakhani; Eynard, Orantin]

$$Z(\beta) \Big|_{\text{JT}} = \beta \text{ (disk)} + e^{-S_0} \beta \text{ (annulus)} + \dots$$

And, more profoundly, for

$$Z(\beta_1) Z(\beta_2) \Big|_{\text{JT}} = \beta_1 \text{ (disk)} \times \beta_2 \text{ (disk)} + e^{-S_0} \beta_1 \text{ (annulus)} + \dots$$

Wormholes, ensembles & (non-)factorisation

Inverse Laplace of connected contribution gives ramp:

$$\int \int_{\beta_1} \int_{\beta_2} \text{wormhole diagram} e^{-\beta_1 E_1 - \beta_2 E_2} d\beta_{1,2} = -\frac{\Delta^2}{2\pi^2 (E_1 - E_2)^2} + \text{reg.}$$

NB: $Z(\beta_1)Z(\beta_2) \Big|_{\text{JT}}^{\text{conn.}} \Leftrightarrow \langle \rho(E_1)\rho(E_2) \rangle_{\text{conn}}$

Gravity contains contributions (wormholes) that strongly suggest an average over an **ensemble** of quantum systems

1. The ensemble is fundamental: bulk theory \cong boundary ensemble
2. The ensemble is emergent: disorder models, quantum chaos, ...

Chaos universality as EFT [Altland, JS]

Generating function of spectral correlations:

$$\mathcal{Z}(\hat{z}) = \frac{\det(z_1 - H) \det(z_2 - H)}{\det(z_3^+ - H) \det(z_4^- - H)} \quad \text{[Wegner; Efetov]}$$

This has an exact $U(2|2)$ causal symmetry, broken spontaneously to

$$U(2|2) \longrightarrow U(1|1) \times U(1|1) \quad (G \longrightarrow H)$$

- Goldstones of this symmetry breaking = EFT of quantum chaos
Reproduces physical content of RMT (i.e. an ensemble!)

$$\int dQ e^{-S[Q;\omega]} \quad \text{where} \quad Q \in G/H := \mathcal{M}(Q)$$

$\mathcal{M}(Q)$ is one of ten (cf. [\[Altland, Zirnbauer\]](#)) Riemannian symmetric superspaces

topological expansion of chaos EFT [Altland, JS]

“Flavor-matrix theory” with topological expansion around two saddles:

$$R_2(s) = e^{s \times 0} \left(\text{cylinder} + \text{pair of pants} + \dots \right) \quad \text{“standard” saddle}$$

“Andreev-Altshuler” saddle $+ e^{2is} \left(\text{cylinder}' + \text{pair of pants}' + \dots \right)$

This results in the famous sine kernel [F. Dyson (1970)]

$$R_2(s) = -\text{Re} \frac{1}{2s^2} (1 - e^{-2is}) = -\frac{\sin^2 s}{s^2}.$$

$$s = \frac{E_1 - E_2}{\pi \Delta}$$

The chaotic wormhole calculus

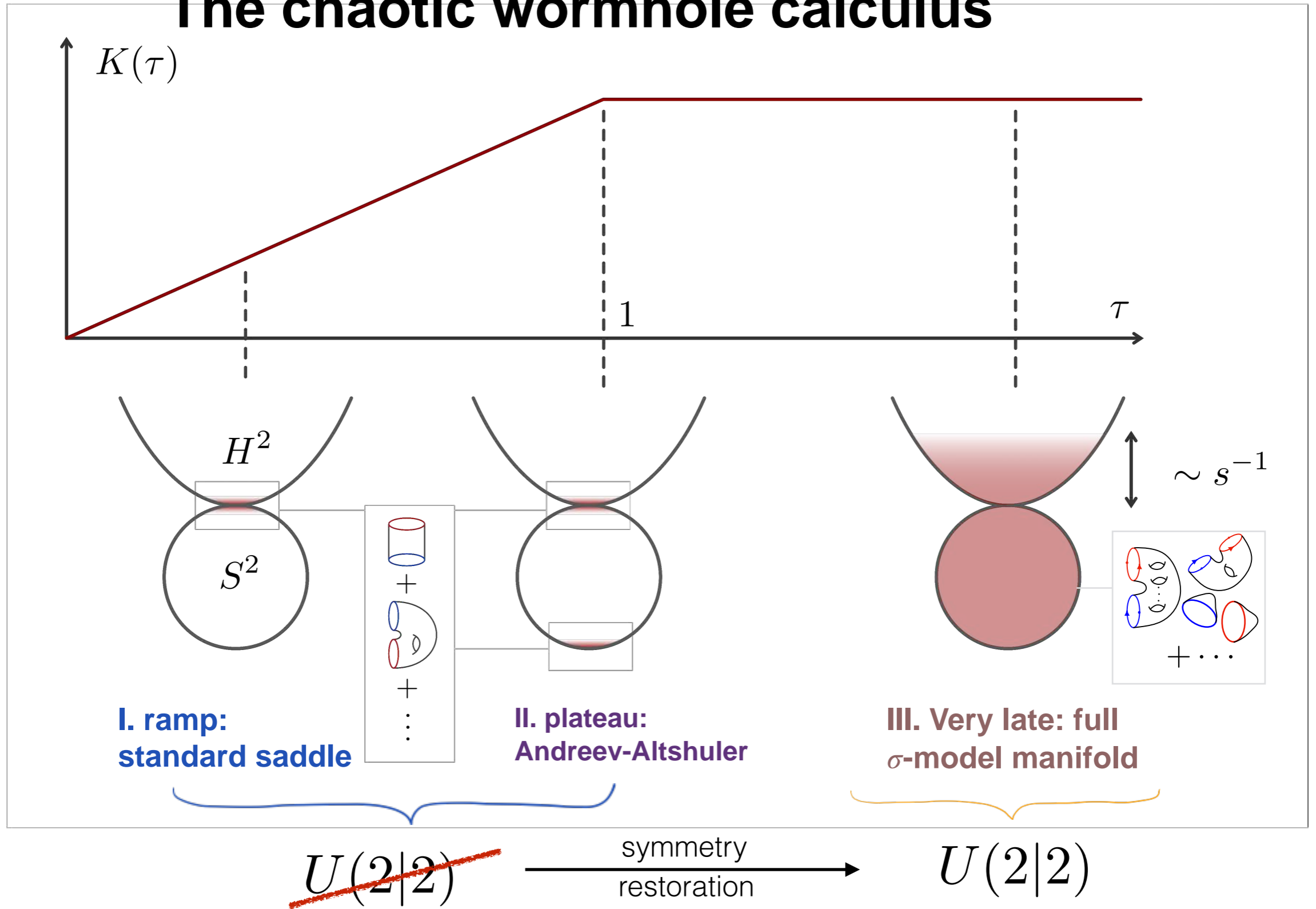

What is the (coherent) bulk picture of all this?

Universe Field Theory for JT

The structure we need: $\mathcal{Z}^{\text{bulk}}[J]$ of multi JT-universe configurations / correlations

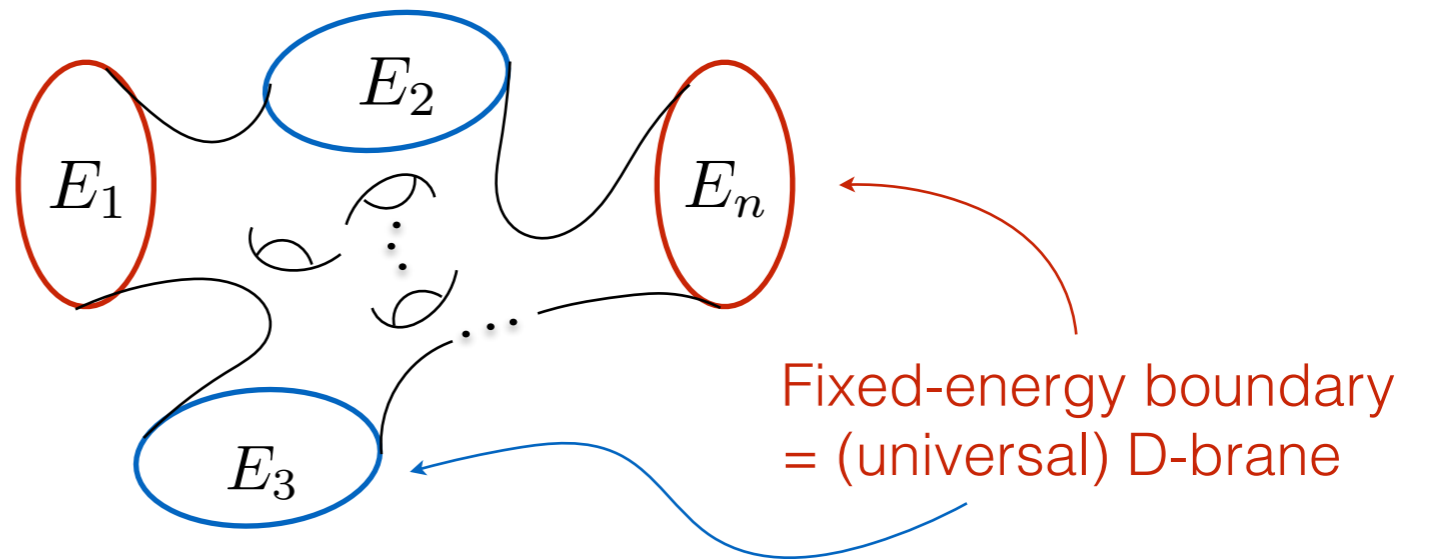
$$\frac{\delta^{(n)} \log \mathcal{Z}^{\text{bulk}}[J]}{\delta J_1 \cdots \delta J_n} =$$

Fixed-energy boundary = (universal) D-brane

[NB: the chaos EFT is such a universe field theory]

Write 2D JT gravity as the world sheet theory of a string and construct its string-field theory description [Post, vd Heijden, E.Verlinde; ...]

Fixed-energy boundary conditions on JT universe = topological D-brane

Quantum Chaos \Leftrightarrow quantum gravity

Spectral determinants become (universe-) D-branes

[see also; Seiberg et. al, Gaiotto et al., Mertens et al.]

$$\psi = e^{\Phi(x)} \equiv \det(x - H) \qquad \psi^\dagger = e^{-\Phi(x)} \equiv \det(x - H)^{-1}$$

Determinant correlators are equivalent to flavour-matrix theory of chaos

$$\left\langle \left\{ e^{\Phi(x_1)} e^{-\Phi(x_1)} \dots e^{\Phi(x_n)} e^{-\Phi(x_n)} \right\} \right\rangle_{\text{KS}} = \int_{(n|n)} dA e^{-e^{S_0} \Gamma(A) + e^{S_0} \text{str} X A}$$

[Altland, Post, JS, vd Heijden, E.Verlinde]

Universe correlations show **causal symmetry breaking** semi-classically
→ gravity explanation of ramp

Universe correlations show **causal symmetry restoration** at the exact quantum level → gravity explanation of plateau

Doubly non-perturbative AdS/CFT

The two EFT saddles are represented by topologically different D-branes (-contours). Compare to baryon in holographic QCD.

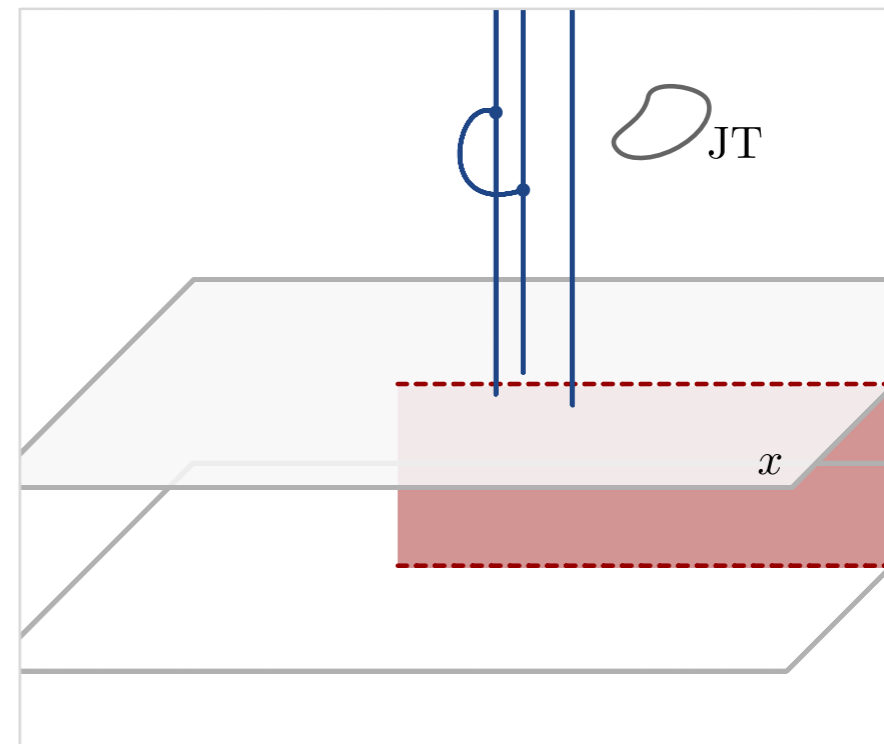
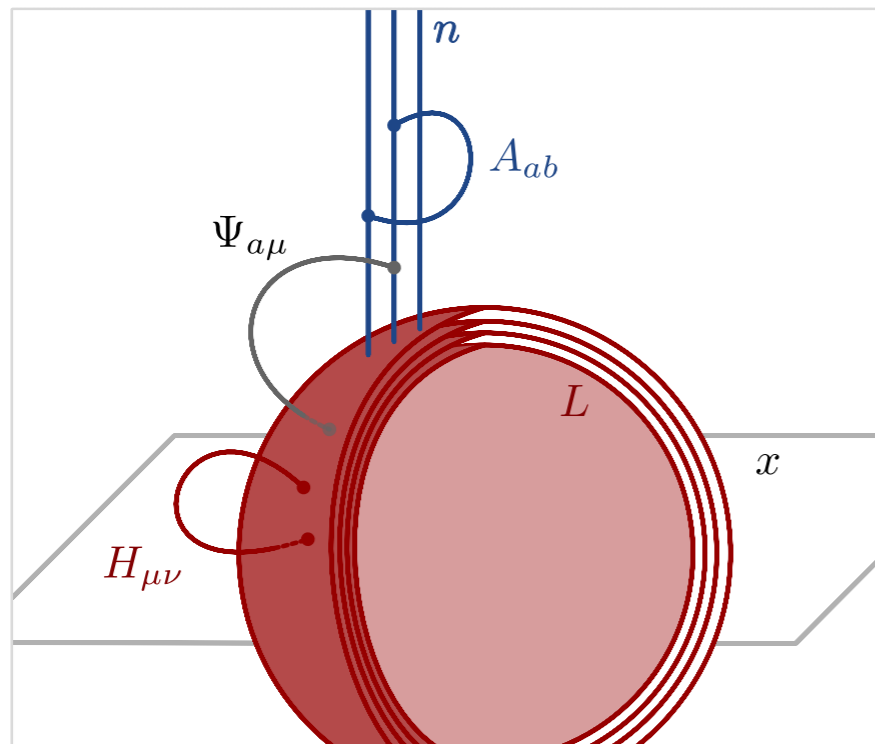

[Altland, Post, JS, vd Heijden, E.Verlinde]

[Aganagic, Dijkgraaf, Klemm, Mariño, Vafa]

A chaotic version of open (CS) / closed (KS) duality

Hints at a deep connection between chaos and (2D) gravity!

Summary: statistical approach to gravity

Quantum chaos is a powerful spectral microscope

“One for all, all for one”

Late-time unitarization \rightarrow saddles of chaos EFT

SYK at band edge \rightarrow JT gravity duality

Topological expansion of ergodic SYK \rightarrow wormhole calculus

Full bulk picture of ramp-plateau: JT \rightarrow Kodaira Spencer

[~ Coleman; Giddings, Strominger; Marolf, Maxfield]

Fluctuations: bulk gravity as moment generating gadget?

Chaos & ensembles in higher-dimensional (holographic) CFT?

For example, chains & arrays of SYK dots?

BULK FICTION



Thank you !